

MEASURE Version 2.51
FILM★STAR
for Microsoft Windows

Advanced Optical Thin Film Technology from



**FTG Software
Associates**

P.O. Box 579 Princeton, NJ 08542
Tel 609 924-6222 Fax 609 482-8060
E-Mail support@ftgsoftware.com

Table of Contents

User Guide	1
Getting Started	1
Installation.....	1
Tutorial.....	2
Scan Method	2
Test Scan.....	5
Spectrophotometer Commands.....	6
Automating MEASURE	7
Reference	8
File Menu	8
Configuration - Capacity	8
Configuration - Directories	8
Configuration - Preferences	9
Configuration - Security.....	11
Configuration - Miscellaneous	12
Setup Menu.....	12
Auto Zero and Background Correction.....	13
Data Type.....	13
Calibrate Wavelength	14
Graph Axes	15
Input Device.....	16
Instrument Settings	18
Spectrophotometer Commands.....	19
Measurement Range	19
Measurement Type.....	20
Program Mode	20
Wavelength List.....	21
Wavelength List Generator	21
Spectra Menu	22
Data Format.....	23
Standard Data Editor.....	25
Tablet Procedures.....	25
Tools Menu.....	26
Macro Commands	26
Macro Reference (DDE).....	26
FilmStar BASIC	33
BASIC Code Generators.....	33
FilmStar MEASURE Extensions	33
FilmStar Workbook	49
File Menu	49
Evaluate Menu	50
Formulas	50
Defined Names	50
CIE Color Module	51
Setup Menu.....	52
Evaluate Menu	52

FSPlot Graphing Module	52
File Menu	53
Setup Menu	53
Data Menu	54
Annotations	54
Annotator	56
Formulator	56
Report Generator	57
Report Setup	58
Report Template	58
General Information	62
Keyboard Commands	62

Index

65

User Guide

Getting Started

FilmStar MEASURE acquires data from *PerkinElmer*, *Agilent (HP)*, *Varian* and *Hitachi* spectrophotometers (see “Input Device” on page 16). The following program files support the listed instruments:

mhp8453.exe	Agilent (HP) 8453
mpe983.exe	PE Lambda 2-45, 9, 650-950 (no URA), 580B - 983G PE Lambda 18/19 Win 98 (PE ISA board)
mpe19AX.exe	PE Lambda 16-19 Win 2000/XP... (Lambda AX board)
mpe950.exe	PE Lambda 650-950 (URA)
mpe1050.exe	PE Lambda 1050 (URA/TDM)
mcary5.exe	Varian Cary 1/100-5/5000
mh3410.exe	Hitachi U-3210/3410 (3200/3400)

Mpe983.exe also supports SummaSketch digitizer tablets. This makes it possible to create data files from spectral strip-charts. In addition, Mpe983.exe controls and acquires data from OOI, StellarNet and Zeiss spectrometers via ActiveX servers. Through its built-in programming modules and ability to communicate with other Windows software, MEASURE can be utilized as a component within an automated quality control system. Finally, MEASURE provides means to control several instruments with the same software.

Installation

If the CD-ROM does not autostart, run **..install\setup32.exe** from Start... Run. An installation password and Administrator privileges are required. Setup will not overwrite previous data files.

MEASURE for Cary spectrophotometers requires that Varian's WinUV scan software is installed. Be sure to close WinUV before running MEASURE.

MEASURE for PE Lambda 650-1050 using mpe950.exe or mpe1050.exe requires that PE's UV WinLab is installed. When not using the URA (Universal Reflectance Accessory), Lambda 650-950 can be controlled by mpe983.exe. Close UV WinLab before running mpe950.exe or mpe1050.exe.

MEASURE for PE Lambda 16/18/19 (mpe19AX.exe) requires the Lambda AX PCI parallel card and dual LPT cable adaptor which are available from FTG Software.

Complete installation as well as update files can be found at

<http://ftgsoftware.com/updates.htm>

We suggest that you visit this page often to keep your software up-to-date.

MEASURE is initially configured with Test Mode ON. Turn this mode OFF (see “Test Mode” on page 9) before attempting to acquire data.

A Security ID Module must be attached to the parallel or USB port. Please report any problems when installing or running FilmStar. Contact information is provided in **Help...About**.

When installing with USB Security ID Module for the first time, DO NOT plug in the module until installation is completed! Windows will automatically locate the new device.

FilmStar provides an extensive set of Help screens. Press <F1> from any menu item or dialog box for context-sensitive help. The help system is identical to this manual's Reference section.

Tutorial

Scan Method

Double-click the FilmStar MEASURE icon. The screen shown below appears. If label **Test Mode** is not displayed, click **File...Configuration...Preferences** and check the box labeled **Spectrophotometer Test Mode**.

Please remember to disable Test Mode when actually acquiring data from your spectrophotometer!

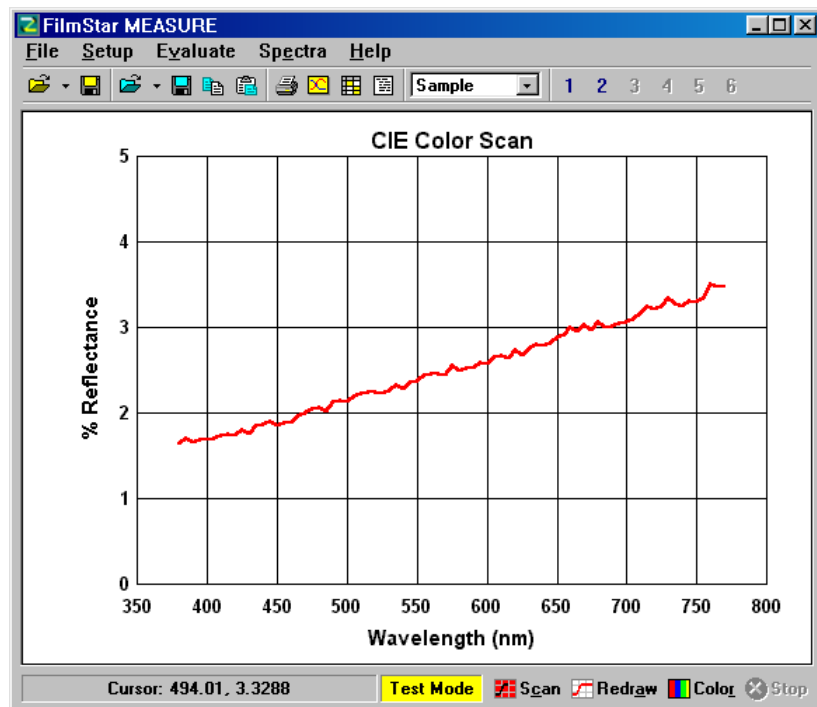

We start by examining the Scan Method (see “Instrument Settings” on page 18) which are edited in linked dialog boxes. Click **Setup...Scan Method <Ctrl+M>**. a Scan Method includes instrument settings, graph ranges, etc. As shown below, Screen 1A selects the **Input Device** which can be a spectrophotometer, digitizer (rarely utilized), or server (raw or processed data).

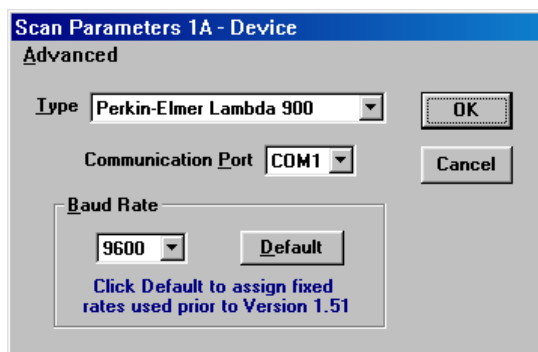

At this point click **OK <Enter>** to accept any changes in the dialog box or click **Cancel <Escape>** to undo any changes. Either key brings you to the next Scan Method screen - **Instrument Settings**. (To quit Scan Method setup and return to the Main Menu, click **Cancel** as each dialog box appears or type **<Alt+F4>** to exit the sequence.)

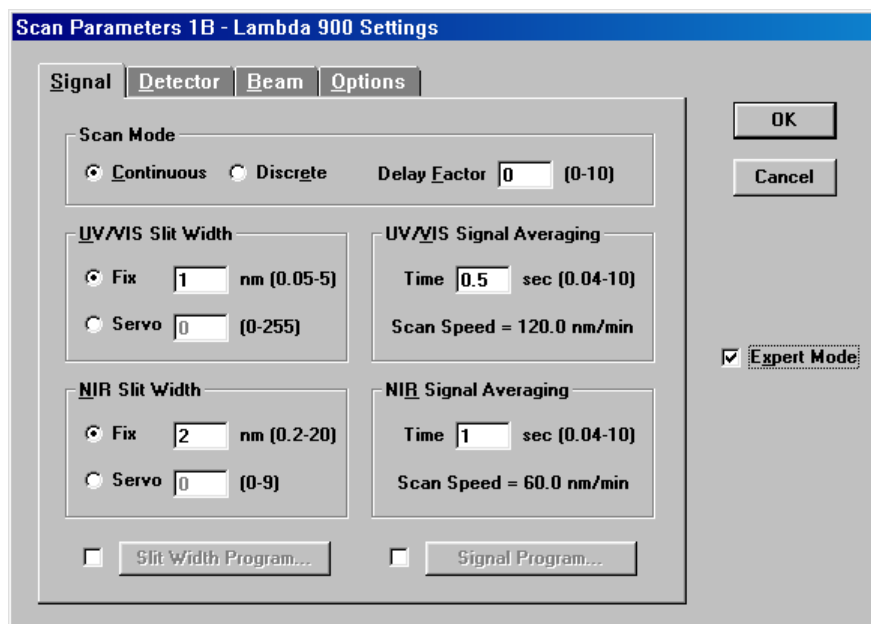

Since choices depend on the particular spectrophotometer, the instrument's manual should be consulted for information about particular settings.

MEASURE supports two **Scan Type** modes:

1. **Continuous...** This is an spectrophotometer's native scan mode, equivalent to pressing the instrument's scan button. A scan range is defined and the instrument slews smoothly from initial to final wavelengths.
2. **Discrete...** The instrument slews to a wavelength, stops, reads transmission values, and proceeds to the next wavelength, etc. Scan ranges may include inverse wavelength spacing or custom lists. Accuracy can be increased with a **Delay Factor**. This causes the instrument to wait

$$t = (\text{Delay Factor}) * (\text{Filter Response}) \text{ seconds}$$

before reading data. Delay Factor is not required in newer instruments using digital technology.

When measuring narrow filters it is might be useful to scan bandpass zones with fine wavelength intervals (*i.e.* 1 nm), and blocking zones with coarse intervals (*i.e.* 10 nm). This ensures accuracy with optimum measurement throughput.

The superiority of one or the other Scan Type mode depends on the particular requirements of the spectrum being measured as well as the characteristics of the spectrophotometer in the spectral region.

Users should convince themselves that a selected scan speed accurately delineates spectral features. Try a test run with a slower speed to see if there are significant differences.

Moving onward by clicking OK or Cancel we arrive at the **Program Mode** screen shown below. Whether one or all **Wavelength Units** are enabled for selection depends on whether Continuous or Discrete scans were selected in the previous screen. The two reflectance modes are discussed in “Data Type” on page 13.

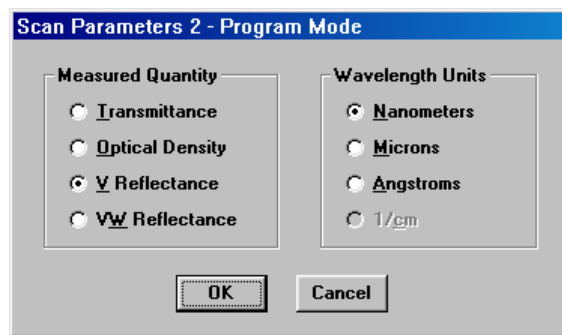

The next screen defines **Measurement Type** for Baseline, Reference and Standard data files. Since there is often no need for Baseline scans with modern instruments, we enter *Constant* next to **Baseline**. (The actual value is assigned later.)

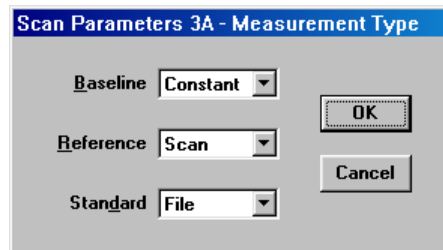

We plan to measure the reflectance of AR coatings on BK7 substrates over the CIE color range 380-780 nm. Since previous experience indicates that best accuracy is obtained if we scan an uncoated substrate (ground second surface) at the start of each measurement series, we enter *Scan* next to **Reference**.

The Reference scan will provide spectrophotometer readings for our BK7 substrate. But what does that really correspond to? Fortunately we have a disk file containing actual BK7 reflectance values as a function of wavelength. In order to use this file we enter *File* next to **Standard**.

Click **OK** or **Cancel** to proceed to the next screen - Measurement Range. The active data entry fields depend on selections made in the previous screen. For example, if you really want to enter Constant = 4.2% for **Standard** instead of file "bk7", you must return to the Main Menu and re-edit the Scan Method.

There are no data entry boxes under **Wave List**, because Continuous rather than Discrete scan mode was specified. A wave list refers to an existing list of wavelengths. For more information see “Wavelength List” on page 21.

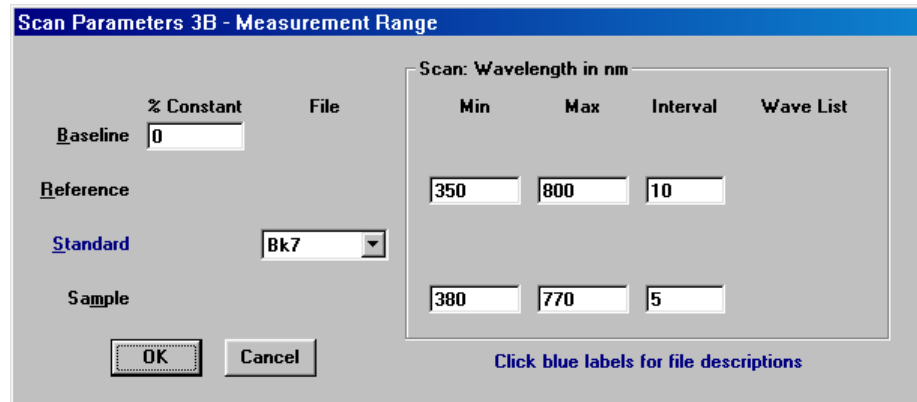

The above dialog can be accessed directly from the Main Menu by clicking **Setup...Measurement Range <Ctrl+A>**. Press OK or Cancel once more for the final Scan Method screen - Graph Axes.

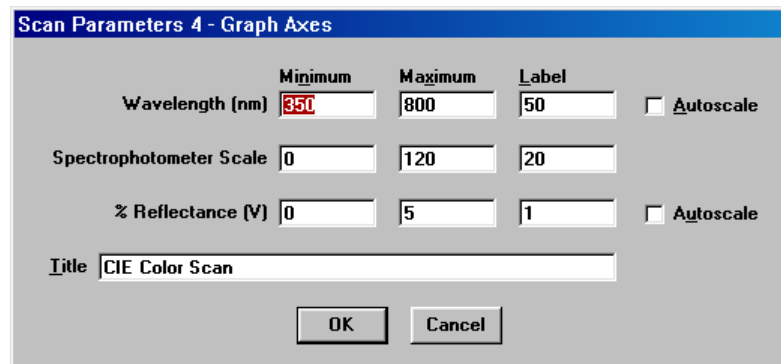

Range and Axes can be edited by without looping through the entire Scan Method.

This dialog can be accessed from the Main Menu by clicking **Setup...Graph Axes <Ctrl+G>**. Note that MEASURE displays different graphs during and after the scan. While scanning the graph monitors actual values sent by the spectrophotometer. Here the vertical scale is set by **Spectrophotometer Scale** settings. This scale is also used for Baseline and Reference readings.

Upon scan completion Sample data is corrected for Baseline, Reference and Standard data arrays. The corrected data is plotted on a user-defined scale, in this case **% Reflectance**.

Test Scan

Place the instrument in Test Mode (*Test Mode* displayed in status bar), click **File...Open <Ctrl+F12>** and load an appropriate Scan Method: "pe2.scw" (use for PE Lambda 2-45), "pe9.scw" or "pe983.scw", etc. These files set MEASURE for %T readings where Baseline = 0%, Reference = 100% and Standard = 100%.

All ".scw" files are not the same. Do not load a Scan Method that is inappropriate for your spectrophotometer or version of MEASURE. If controlling more than one instrument with the same computer, use different directories.

Click **Scan <Alt+C>**. The Test Mode trace is a straight line.

Disable **Test Mode** in **File...Configuration...Preferences**. We're ready to see if MEASURE really works with your instrument. Click **Setup...Initialize <Ctrl+I>** (if available) to issue initialization commands. Normally you are prompted for initialization after loading a new Scan Method. Since we've just switched from Test Mode we issue the command manually to test it.

Depending on instrument, the status bar at the lower left might now display "Initializing - please wait" for a few seconds. Depending on instrument, a series of messages provides feedback that things are working properly. If there is a communications error MEASURE ultimately issues an appropriate message.

If that happens, there are several possibilities:

1. Is the correct cable installed? If a RS-232 modem cable doesn't work try a null-modem cable or adapter. Lambda 2 and similar older models require a custom 25 pin to 9 pin connector (contact PE).
2. Was the correct COM port or GPIB device specified in the Scan Method?
3. Does the serial configuration match those expected by MEASURE?
4. Lambda 950-1050 with URA (universal reflectance attachment) or TDM (triple detector module) requires UV WinLab. Do not run MEASURE and UV WinLab simultaneously.
5. Cary operation requires Win UV installation. Do not run MEASURE and Win UV simultaneously.
6. Lambda 18/19 (Windows 2000/XP) requires a computer with built-in LPT (parallel port). A Lambda AX board adds a second LPT port.

For further details, see "Input Device" on page 16.

Remove any optic or reflectance attachment from the sample chamber.

Click **Scan <Alt+C>** and listen for the sound of your instrument's scanning motor. The graph will update as data is acquired. If you don't see a trace click **Spectra... Data Table** to view the data in tabular form. Possibly data are out-of-range for the graph axes.

If the spectrum is not flat at T=100%, it can be corrected with a Reference scan. Click **Setup...Scan Method <Ctrl+M>** and set **Reference** to **Scan** in Screen 3A (Measurement Type). In Screen 3B (Measurement Range), enter **Reference Min**, **Max** and **Interval** values. Note that **Standard** remains equal to 100%.

Upon returning to the Main Menu, place MEASURE in Reference mode with **Setup...Data Type...Reference <Ctrl+R>**. Click **Scan <Alt+C>** to acquire data. At the conclusion of the Reference scan, return to Sample mode and scan again. Is the spectrum now flat at 100%T? Finally, place an optic in the sample chamber and measure its transmission.

Spectrophotometer Commands

Setup...Commands <F2>

Since a number of instruments can only be operated from a computer, we include **Commander** screens as illustrated below. The **Wavelength-Ordinate-Slit** live display text box is automatically updated several times each second.

Type a command *without the leading '\$' character* in the **Command** box and click **Execute**. Click **Commands** for a pull-down menu with useful commands. Click **Commands...Scan Method <Ctrl+M>** to access Instrument Settings (Scan Method screens 1A and 1B).



Automating MEASURE

While most users will (at first) think of MEASURE as a standalone program, it can also be used as a component within a larger Windows applications. A typical example is quality control. Spectra must be measured and interpreted according to specific criteria such as CIE color or bandwidth. Documentation including spectral curves may be required. The user might also want to store results on disk and update a database with relevant information.

The application can also isolate technicians from the complexities of instrument and software setup. In the example illustrated below, the technician inserts an optic in the sample chamber, selects a QC Procedure and clicks **OK**.

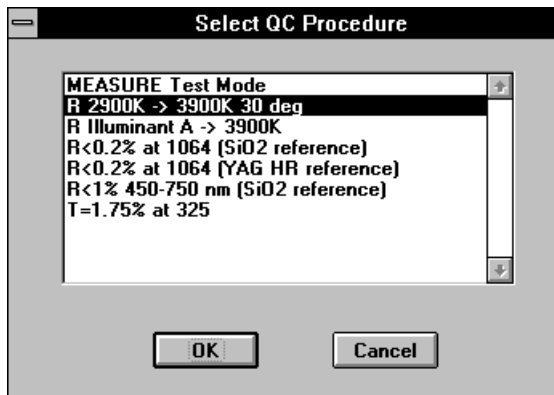

Reference

File Menu

Open <Ctrl+F12>, Save <Shift+F12>, Save As <F12>

The Scan Method file (name displayed in Windows title box) is opened and saved in the File Menu. Wavelength List files are accessed in the Setup menu and spectral data files through the Spectra menu.

Copy Graphics

Copies the current screen graphic to the clipboard for pasting into other applications.

Print Graphics <Shift+Ctrl+F12>

Print the screen graphic to the current Windows default printer. Best results are obtained with a white background.

Exit <Alt+F4>

Upon exiting configuration file "..\winfilm\config\measure.ini" is updated. The current Scan Method is automatically saved in file "work.scw".

Configuration - Capacity

File...Configuration...Capacity

Users can configure MEASURE for optimum memory utilization by entering values which do not exceed anticipated maxima. Changes are implemented when MEASURE is exited and restarted. Failure to allocate sufficient space usually leads to a 'Subscript out of range' error.

It is not necessary to scan wavelengths at the same interval for each data type. Baseline, Reference and Standard data will be interpolated at the Sample scan interval. That is, reference data scanned every 10 nm can be used with sample data scanned every 1 nm.

Configuration - Directories

File...Configuration...Directories

MEASURE uses four file extensions for storing and loading different types of data. Files are stored in three default directories. While files can be loaded from any directory, they can only be stored in default directories. (Exception: spectral sample data files can be stored anywhere.)

Data

Scan Method (*.scw) and Wavelength List (*.wls).

Sample

Spectral data files (*.csv) in 'comma-separated values' ASCII format. These files can be loaded as Excel worksheets. Since ".csv" is a standard Excel

extension, users should create unique directories for spectral data files: i.e. "c:\excel\spectra". These files can be loaded directly into MEASURE.

Reference/Baseline/Standard

Data files in ASCII format (Reference/Baseline *.dat, Standard *.csv)

Database Configuration

FilmStar BASIC programs can be assigned to *DB Retrieve* and *DB Save* menu commands in the File and Spectra menus. An example is the FileMaker Pro database solution included with FilmStar. The examples show how database technology and ActiveX provide means to sort and select measured spectra. Users are not restricted to FileMaker Pro. MS Access programmers can develop similar functionality.

Enter file names of BASIC programs to be assigned to menu commands. Click **Edit...Select <F3>** to browse and select files.

Configuration - Preferences

File...Configuration...Preferences

Use Windows message box

Message boxes display **OK Cancel**, **Yes No** and similar messages. You have a choice of Windows default message boxes (screen centered) or FTG Software message boxes (usually centered in active window). Windows message boxes support Windows sound effects. You may find FTG message boxes somewhat easier to read.

Cancel warning

Warning message upon leaving a data entry form with **Cancel**.

Overwrite warning

Warning when opening a new file or saving a file after changes in the data.

Automatic Edit

Edit the Scan Method immediately after loading a new file from disk.

New axes

Automatically draw new axes when Graph Axes parameters are changed. Turn off this feature to superimpose %R and %T plots on the same graph.

Test Mode

Especially useful for developing FilmStar BASIC programs off-line. The words *Test Mode* are displayed in MEASURE's status bar.

There are occasions, *i.e.* when developing quality-control models, when realistic data are required in Test Mode. This is accomplished by selecting **Test Files...** and specifying a Baseline, Reference and/or Sample file names. Advanced users should note that these file names can also be specified via DDE. These file names are ignored when Test Mode is deactivated.

Display and save file descriptions

Check to save and list file descriptions (50 characters maximum). This facility is a carry-over from 16-bit Windows (8 character file names). The option adds **File...List** and **Spectra...List** commands.

The above preferences are automatically stored upon exiting MEASURE and responding **Yes** to 'Save new configuration'. The following advanced preferences are set by manually editing "..\winfilm\config\measure.ini". Do not type

comments (starting with ;) on the same line as a setting. The values shown are usually the default values assigned when any of these lines are not in "measure.ini". Lines can be added anywhere in the appropriate section.

CIE User-Illuminants

Users can add any number of illuminant files as follows. For further information see "CIE Color Module" on page 51.

```
[CIE Color]
Illum1=Xenon Lamp;arclamps\xenon.csv
Illum2=Fluorescent Cool;fcool.csv
Illum3=Fluorescent Warm;fwarm.csv
```

The first description appearing in the pull-down illuminant list is *Xenon Lamp* and the corresponding file name is *xenon.csv*. Files should be stored the FilmStar program directory (usually c:\winfilm), but an optional subdirectory (arclamps) can be added.

Status Label

The status label font at the screen lower left can be changed from bold (default) to normal; text alignment can be changed from center (default) to left or right justification. Enter or edit the following line(s):

```
[Configuration]
StatusLabelBold=-1 ;0=normal font, -1=bold font
StatusLabelAlign=2 ;0=left, 1=right, 2=center justify
```

Scan graph background color

Colors displayed during spectrophotometer scans may be adjusted with the following line(s):

```
[Configuration]
ScanBackColor=12 ;red
ScanAxesColor=7 ;gray
ScanLineColor=0 ;black
```

where

0	Black	8	Dark Gray
1	Dark Blue	9	Blue
2	Dark Green	10	Green
3	Dark Cyan	11	Cyan
4	Dark Red	12	Red
5	Dark Magenta	13	Magenta
6	Dark Yellow	14	Yellow
7	Gray	15	White

Stop button enabled

It is possible to abort a continuous scan by clicking **Stop <Esc>**. Users can enable/disable this and related functions by adjusted the following line(s). 0 is False (no) and -1 is True (yes).

```
[Configuration]
AutoModeStop=0 ;Enable Stop when Auto-Activate ON
ContinuousScanStop=-1 ;Enable Stop in continuous scan
DiscreteScanWarn=-1 ;Warning after discrete scan Stop
```

Prevent overwriting J-CAMP .dx files loaded from disk

To help minimize the inadvertent corruption of J-CAMP data files loaded from disk, set the following flag. You can still overwrite a file with the same name, but only after a scan is performed.

```
[Files]
NoOverWriteDX=-1
```

PerkinElmer break character

When stopping a continuous scan (PE only), a break character is sent to the spectrophotometer. Normally this is ASCII 35 (#), but can be changed if necessary. This adjustment is included because of uncertainty regarding 983 models, and the possibility of changing the break character on the Lambda 2. It should not be changed for Lambda 5/7/9 and has no effect for Lambda 19.

```
[Configuration]
BreakCharacter=35 ;Break character is ASCII 35
```

PerkinElmer startup initialization prompt

When MEASURE first starts the 'Reinitialize' prompt appears for PE Lambda models. The prompt can be suppressed as shown below.

```
[Configuration]
StartUpInit=0 ;No Reinitialize' prompt at startup
```

HP 8453 Buttons

Normally HP 8453 buttons are disabled. This ensures that control is from the computer, especially when running FilmStar BASIC macros. To enable the buttons enter the following line.

```
[HP 8453]
EnableButtons=-1
```

Multiple Instruments

This is only required when two or more spectrophotometers *of the same type* are connected to the same computer *and* Wavelength Calibration is being utilized. When enabled, Instrument 1-4 is selected in the Scan Method 1A Device dialog.

```
[Configuration]
MultiInstruments=-1
```

Configuration - Security

File...Configuration...Security

ID Module

An FTG Software HASP Security ID Module must be attached to the parallel (printer) or USB port. HASP modules are embedded with company name. Users who experience difficulties should visit

<http://www.ftgsoftware.com/issues.htm>

and click *Security ID Module doesn't work* under *Installation & Startup*.

Configuration - Miscellaneous

File...Configuration...Misc

Graph Axes Labels provides the means to replace English graph axes labels with international equivalents. Labels apply to the FSPlot Module as well as the main screen.

Setup Menu

The Setup Menu establishes numerous program conditions. Some selections do not apply to instruments which do not support the particular feature.

Data Type

Select Sample, Baseline, Reference or Standard data files. Baseline and Reference modes are enabled or disabled according to the Scan Method. Single Beam Mode (energy scan) is supported for Lambda 650-1050.

Scan Method <Ctrl+M>

Edit instrument parameters in a series of linked screens. The Scan Method is opened and saved in the File Menu.

- 1a Select input device and COM port
- 1b Spectrophotometer settings
- 2 Program mode - plot type and units
- 3a Measurement Type - select Constant/File/Scan for each Data Type
- 3b Measurement Range - specify scan range, file names and/or constants
- 4 Graph Axes - specify graph axes for measured and reduced data

Measurement Range <Ctrl+A>

Instant access to Scan Method Screen 3B.

Graph Axes <Ctrl+G>

Instant access to Scan Method Screen 4.

Wavelength List

Generate a custom wavelength list for acquiring data at specified wavelengths using Discrete scan type (set in Scan Method screen 1b).

Initialize

Execute instrument-dependent commands such as Page 1 (Lambda 9), lamp configuration (Lambda 2/19), slit width (Lambda 2/5/7/9), detector switch wavelength (Lambda 9/19), NIR sensitivity (Lambda 9/19), etc. This command must be executed at startup and whenever instrument parameters have changed.

Spectrum 2000 users should issue this command if the current Spectrum setup (.set) file has been changed by another program.

Calibrate Wavelength

Determine wavelength correction functions from a series of known wavelengths.

Auto Zero (Background Correction)

Perform auto zero and background correction using the spectrophotometer's internal capability. Users must use baseline and/or reference scans for older models which do not support automatic correction.

Lamps ON

Allows Lambda 2/19/900 users to turn lamps off to conserve bulb life. This is a toggle command which is checked when the lamp is on. When turning bulbs back on, be sure to allow sufficient time for stabilization.

Commands <F2>

Send commands directly. Especially useful for slewing the instrument to a particular wavelength.

Auto Zero and Background Correction

Setup...Auto Zero

Enter the anticipated wavelength range/scan speed. The Scan Speed can usually be greater than the sample scan speed when the spectral response of the reference optic or empty sample compartment is relatively flat. Calibration must be repeated for different sample holders and masks. **Use Scan Range Settings** updates displayed values with the current Scan Method settings.

PE auto zero settings are saved in configuration file
"\\winfilm\config\measure.ini".

Since there is no built-in background correction, Lambda 900 models do not require an auto-zero function. Users should use MEASURE's Reference mode to duplicate this functionality.

Data Type

Setup...Data Type

There are four data types in MEASURE:

Sample

Scan with coated optic mounted in the sample chamber. Measured values are displayed during data acquisition (spectrophotometer units, 0-100% T); Reduced (final) values are displayed upon returning to the Main Menu (physical units 0-100% R/T or OD). If required, Baseline and Reference scans must precede any Sample scan.

Baseline

'Zero' reading corresponding to scanning when the sample compartment is blocked. Baseline data can be stored on disk and automatically utilized in Sample scans. In modern instruments, baseline measurements are often not needed. This depends, however, on measurement scale. Baseline scans may be required when for very low reflectance sample where background noise (scatter) can be significant.

Reference (PE-2000 Background)

Scan with empty sample compartment or uncoated optic. Reference data can be stored on disk and automatically utilized in Sample scans.

%T or OD	100% scan (sample removed)
%R (V)	Uncoated scan (uncoated glass, reference reflector, etc.)

%R (VW)	V-path scan
%R (VN)	V-path scan for PE URA (mpe950.exe)

Scan with empty sample compartment or uncoated optic. Reference data can be stored on disk and automatically utilized in Sample scans.

Standard

Independently determined %T or %R values corresponding to the Reference scan. A typical example is the V mode reflectance of an AR coating on glass: Reference data is the measured spectrum of the uncoated glass; Standard data is the known reflectance.

Standard data is not used in VW mode. Data can be edited in MEASURE and stored on disk for automatic utilization in Sample scans.

Reduced Sample values are given by

%T/OD/%R(V)	$Y=Y_{std} * (Y_{mea} - Y_{bas}) / (Y_{ref} - Y_{bas})$
%R(VW)	$Y=\text{SQRT}((Y_{mea} - Y_{bas}) / (Y_{ref} - Y_{bas}))$
%R(VN)	$Y=(Y_{mea} - Y_{bas}) / (Y_{ref} - Y_{bas})$ {PE URA}

where Y = Final Sample in user-defined units, Y_{mea} = Measured Sample in instrument %T units, Y_{bas} = Baseline, Y_{ref} = Reference, and Y_{std} = Standard.

As specified in Scan Method screen 3A, constants, data files or scans may be used for Baseline and Reference data. Constants and data files may be used for Standard data which may not be scanned.

There may be no need for Reference scans or Standard data in %T measurements for instruments which have built-in 100% reference correction (sometimes called *Autozero*); in such cases specify Reference = 100%. Note that newer instruments do not have built-in 100% correction, relying instead on the controlling software.

The user should convince himself that an instrument's built-in zero or 100% correction is sufficiently accurate and repeatable for the measurements being performed.

If Constants are used for all three data types and have respective values Baseline 0%, Reference=100%, and Standard=100%, measured and reduced values are equal and Sample data is labeled Absolute'.

Calibrate Wavelength

Setup...Calibrate Wavelength

This dialog provides means to set up wavelength correction functions. While such correction functions are probably not required (some instruments have built-in calibration), they are included just-in-case.

Enter 3 to 6 known wavelengths which are as widely spaced as possible over the range of interest. Click **Get Coefficients** to compute a quadratic fitting function and **Test** to test the function.

Correction routines are different depending on whether *Continuous* or *Discrete* scan is specified in the Scan Method. In continuous scanning (the usual mode) measured wavelength arrays contain corrected values. If *Auto-convert Sample* is checked, the Sample spectrum is finally converted to the Scan Range specified in the Scan Method.

In discrete scanning, the instrument slews to the instrument wavelength corresponding to the required value specified in Scan Range. For example, suppose instrument = 550 nm really corresponds to 552 nm. In continuous scanning the instrument measures at 552. Then if *Auto-convert Sample* is checked the value at

550 nm is derived by interpolation. In discrete scanning the instrument is driven to 548 corresponding to an actual value of 550.

Graph Axes

Setup...Graph Axes <Ctrl+G>

During data acquisition the user observes measured transmittance values. When the scan is completed the graph is replaced by another one showing corrected (reduced) data.

Wavelength

The wavelength range need not be the same as the scan range. Try range 350 - 800 x 50 nm when scanning from 380 to 780 nm (CIE color coordinates) for a more pleasing graph.

Spectrophotometer Scale

Actual instrument readings in %T units. It may be necessary to set the minimum < 0 for proper graphing when measuring blocking regions. Setting the maximum > 100% may also be necessary.

Transmittance (Reflectance)

Scale for reduced (compensated for baseline, reference and standard values) data. In addition to the graph title, labels may be placed on the graph by pressing <Shift+Click> when the cursor is in the plot area (crosshair shape).

Autoscale

When scanning, wavelength range is determined from the scan range. After the scan vertical axis range is computed from maximum and minimum spectral values. Autoscale is also performed when opening, pasting or importing data. Turn off Autoscale to display multiple spectra on the same graph, since axes are recalculated and redrawn after each scan.

Graph Details...Line Color <Alt+R>

Spectral line color is most easily changed by clicking the Color Button at the lower right. Any spectrum in memory is replotted in the selected color. To *suppress* replotting hold down the shift key while clicking the button.

To change colors with the keyboard, press <Alt+R>, use left and right arrow keys to select and press <Enter>. Press <Shift+Alt+R> to change colors without replotting the current spectrum. Colors can also be selected with a single keystroke:

black, Red, Yellow, Blue, Green, Magenta, Cyan, White

There are two color palettes which are automatically selected according to the graph background. To suppress the dark palette click **Graph Details...No Dark Palette**.

Graph Details...Clip Plot

When this command is checked, spectral plots are 'clipped' and traces do not protrude beyond the graph axes. By turning off this function, replot speed may be increased on your computer. Speed is also increased by turning off the **Thick Line** selection.

Graph Details...Auto Color, Auto Axes

Auto Color automatically selects a new line color when a spectrum is scanned, loaded, or pasted. This is useful for comparing spectra. **Auto Axes** automatically redraws new axes when a spectrum is scanned, loaded, or

pasted. That is, only one spectrum can be viewed a time. Note that Auto Axes disables Auto Color.

Input Device

Setup...Scan Method <Ctrl+M> (Screen 1A)

MEASURE uses the following RS-232 default serial port settings:

SummaSketch Tablet	9600,0,8,1
PE Lambda 2..45	4800,N,8,1
PE Lambda 5/7/9, 983G	4800,E,7,1
PE Lambda 900	9600,N,8,1
PE 983	9600,E,7,1
PE 881/882/883	9600,N,8,1
Hitachi U-3210/3410	4800,E,7,2

The difference between SummaSketch and SummaSketch II is that MEASURE can automatically set the newer model to ASCII output format. Users with the older tablet may need to open the instrument and adjust a jumper wire.

Click **Advanced** to enable serial CD (carrier detect) and/or CTS (clear to send) error checking or to disable timeout errors. By enabling CD or CTS (we are not sure which works on which spectrophotometer) the program will give instant notification of communication errors rather than wait for timeout errors (5 sec minimum but could be minutes). Disabling timeout errors may be required if your computer cannot handle multitasking.

Special Notes:

1. **PE Lambda 5/7/9:** If your instrument was originally delivered with a PE Data Station (pre-IBM PC era) you should modify the LP125 RS-232 interface board by installing a jumper wire as shown in the following diagram taken from PE Service Data Bulletin 9-6, 30 June 1987:

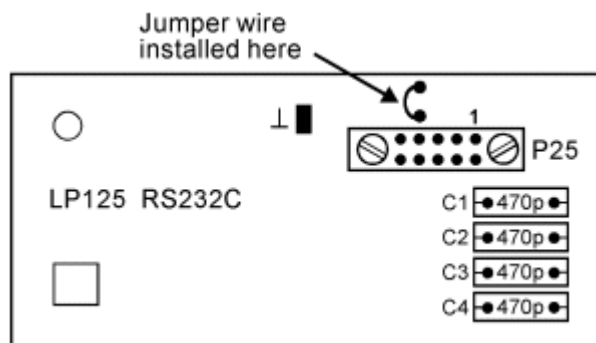

For further information on this modification please contact the PerkinElmer service department.

- 2a. **PE Lambda 19:** This solution is supported on computers with built-in LPT port. A PCI board adds LPT2. A custom cable combines the two ports into a 37 pin Lambda connector. Contact FTG Software to purchase the board.

NOTE: If the following is outside your comfort zone please contact FTG Software or your IT department for assistance.

Installation of LPT2 is not automatic. Run the Control Panel Add Hardware wizard and (after installing MEASURE for Lambda 18/19) locate

the following installation file (copied to your hard disk during FilmStar setup) in response to 'Have Disk'.

c:\Winfilm\TVicLPT\SETUP_NT.INF

Several wizard passes are necessary for complete installation. When the wizards are finally done, locate the above INF file in Windows Explorer, right click on it and then click Install.

In Control Panel select System and click the Hardware Tab followed by Device Manager.

- a. Right click on PCI Parallel Port, select Properties, and access Port Settings; set LPT Port Number to LPT2 (it will probably indicate LPT3) and *Filter Resource Method* to 'Never use an interrupt'.
- b. Right click on LPT1 and change Port Settings *Filter Resource Method* to 'Use any interrupt assigned to the port'; also check that Resources IRQ is set to 07 (normally is).

Click here for further information.

- 2b. **PE Lambda 2/10/12/14 etc:** The 25-pin male connector can be configured as printer or computer port in *SuperUser* mode. A custom cable may be required.
3. **H-P 8453 Diode Array:** The GPIB (HPIB, IEEE-488) card is used. There are various configurations as indicated below. Configuration is specified in ..\winfilm\config\measure.ini before starting MEASURE. If you have problems, please contact FTG Software.

- a. National Instruments cards (ISA/PCI/PCMCIA). You should not need to change default properties. We suggest you reset the HP 8453 address to 8 (dipswitch settings 00001000). This corresponds to the default *GPIB Device Name* DEV8 in Scan Method screen 1A (Input Device).

[HP 8453]

IEEE488=NI488,GPIB0

- c. Agilent HP-IB boards require Agilent's Standard Instrument Control Library (SICL). Enter the 8453's HP-IB address in *HP-IB Device Address* in Scan Method screen 1A (Input Device). While it is not necessary for ChemStation to be installed, it may be advisable as Agilent technicians will not be familiar with FilmStar.

[HP 8453]

IEEE488=HPSICL,Hpib7

4. **Varian Cary 1/100-5/500, etc.:** MEASURE communicates via cary32.dll. This required system file is installed by Varian's WinUV package. Note that WinUV must be closed while running MEASURE.
5. **ActiveX Server:** This 'device', included in the PE version of MEASURE, enables communication with ActiveX EXE servers controlling diode-array and FTIR spectrometers. Since the servers can be utilized by other software, baseline and reference calculations are performed in the server rather than in MEASURE. The server returns a corrected spectrum.

ActiveX servers are controlled by FilmStar BASIC macros. For ease-of-use, macro commands can be assigned to commands in the Setup menu and to the Scan button.

6. **Hitachi U-3210/3410 (3200/3400):** A null-modem cable is required. Communication settings are fixed at default E,7,2; the maximum baud rate is 4800. In the case of communication errors, turn off the machine, remove the serial interface board and locate switch S1. Set B6 to ON and all other settings to OFF. Do not adjust switch S3.

Parameters such as scan speed and wavelength range are not set individually. Instead, they are bundled and stored in instrument Menu 1-20. MEASURE provides means to load from disk, download from the U-3410, upload to the U-3410, edit, and save parameters on disk.

Note that the Hitachi Measurement Range screen includes an additional Menu Number column where the user specifies which parameters will be used during Baseline, Reference and Sample scans.

Before scanning, the user should ensure that the parameters stored in the Hitachi U-3210/3410 correspond to Menu Numbers specified in the Measurement Range dialog. Scanning may alter previous values stored in Hitachi Menus. Please refer to Hitachi documentation for descriptions of parameter settings.

7. **PE Lambda 650-1050 using mpe950.exe or mpe1050.exe:** *UV WinLab* library MSLambdaServer.exe connects the instrument to MEASURE. If there are errors when MEASURE connects to the server, it is likely that MSLambdaServer.exe was not terminated properly. Use **<Alt-Ctrl-Del>** to bring up the Windows Task Manager and then delete MSLambdaServer from the Processes list. Alternatively, reboot your computer.

Instrument Settings

Setup...Scan Method <Ctrl+M> (Screen 1B)

MEASURE supports two Scan Mode types:

Continuous

Normal built-in scan method. Scans are usually specified in the instruments 'native' units. In IR instruments (1/cm native units), scans may also be specified in nanometers and microns. Here the actual scan is in 1/cm and final results are interpolated.

Discrete

Special MEASURE scan method. Scan may be specified in any wavelength unit. Wavelength Lists and scan intervals Interval < 0 (closer spacing at short wavelengths) are supported.

In Discrete Mode the instrument slews to the next wavelength and acquires data. A **Delay Factor** may be specified. After slewing to the next wavelength, the instrument waits Delay Factor times **Filter Response** before starting the measurement. This mode is not supported in FTIR instruments.

Note the following instrument-dependent settings and characteristics:

1. **PE Lambda 2...**Slits are fixed at 2 nm; 'Smoothing' simulates variable slit width electronically.
2. **PE Lambda 19...**Includes an Integration Time setting and does not require a Delay Factor setting.
3. **PE 88x/983G...**Delay Factor is actual delay in seconds. Noise Filter=0 (.5 on the VDU) is not allowed for Scan Modes=5 to 7. If this rule is violated an error occurs at the beginning of the scan.

4. **PE Lambda 650-1050**...PMT Gain applies only to Single Beam Mode (diagnostic energy scan).

ActiveX Commands

This dialog appears when *ActiveX Server* is selected as input device. In this mode data acquisition and normalization (reference correction, etc.) are performed in an external server. As servers can be utilized by other Windows programs, this is different from devices actually controlled by MEASURE.

Servers are accessed and controlled through FilmStar BASIC macros. Entering file names enables Setup menu entries for Initialize, Dark, and Reference scans; the MEASURE Scan button is assigned to the Sample Scan entry. Use **Edit Select <F3>** to browse for BASIC file names.

Device Name lets you replace the default name *ActiveX Server* with a more appropriate device name which appears in status boxes and, most importantly, in the *SPECTROMETER* entry in J-CAMP (.dx) files.

Spectrophotometer Commands

Setup...Commands <F2>

Send various direct commands. Type the command and click **Execute**. A list of commands can be obtained from PerkinElmer. Some commands have been programmed and are accessed with **Commands**. Select **Scan Method <Ctrl+M>** to adjust instrument settings. Most erroneous commands return an error message.

Measurement Range

Setup...Scan Method <Ctrl+M> (Screen 3B)

The contents of this screen depend on selections in the previous **Measurement Type** screen (Scan Method screen 3A) where the type of data (Constant, File, and Scan) is specified for Baseline, Reference and Standard modes.

Constant

Enter a constant value in %. For transmission measurements with modern self-correcting spectrophotometers, Baseline = 0%, Reference = 100% and Standard = 100% are typical. If you are not satisfied with the instrument's built-in 100% correction, the Reference should be scanned.

For 'V' reflection with a glass substrate typical values are Baseline = 0% and Standard = 4.2%. Reference data must be scanned or loaded from disk.

File

Type the name of a previously stored data file. This file will be automatically loaded and utilized during data acquisition. For example, Standard Constant = 4.2% could be replaced with File BK7.

Scan

Enter numerical values corresponding to continuous or discrete scan modes.

Note the following for particular instruments:

1. **SummaSketch**...Sample scan values are utilized in **Spectra...Convert Table**. This allows digitizer scans to be converted to regularly spaced wavelength intervals or lists. Otherwise, scan ranges are ignored when using the digitizer.
2. **PE Lambda**...In continuous scan mode intervals larger than 1 nm must be integers. For example, 2.5 nm is not allowed.

3. **680/780/88x/983/983G**...In continuous scan mode intervals larger than 1 cm⁻¹ must be integers. For example, 2.5 cm⁻¹ is not allowed. When scanning in nm or μm the actual data is collected in cm⁻¹ with the final array calculated by interpolation.

Discrete scan mode is more flexible and possibly more accurate. Depending on settings, it can be faster or slower than continuous scan mode.

In Discrete mode Interval < 0 may provide faster data acquisition using inverse spacing. As an example let Min=400 nm, Max=800 and Interval=-10. The actual wavelength interval changes from 10 nm at 400 nm to 20 at 800. Negative Interval cannot be utilized in continuous scan mode.

Instead of a numerical range, you can enter the file name of a previously stored wavelength list created with **Setup...Wavelength List**. Click the label **List Name** to view the list of available files.

Measurement Type

Setup...Scan Method <Ctrl+M> (Screen 3A)

Specifies the type of data to be utilized in Baseline, Reference and Standard modes. Scanning is the only way to acquire data in Sample mode.

Constant

A constant cannot be used for Reference data in VW (VN for PE URA) mode.

File

Use data previously scanned and stored on disk.

Users must be certain that the utilization of previously stored data files does not adversely affect experimental accuracy.

Scan

Baseline or Reference data will be acquired by scanning. Data must be acquired before the Sample scan. The scan remains in memory until the program is exited.

Auto VN (mpe950.exe, PE URA only)

This Reference mode specifies that the PE Data Server will (as in *UV Win-Lab*) automatically normalize spectra. Only a Sample scan seems possible, but the 0% baseline (if Scan selected under Baseline) and 100% reference are measured but not displayed. That is, there are actually two or three scans for each sample scan. This mode is useful for a series of scans at different angles. The danger is that the user does not view reference scans, thereby eliminating visual verification that 'all is well'.

Program Mode

Setup...Scan Method <Ctrl+M> (Screen 2)

Select program mode and wavelength units. Wavelength units can only be selected in discrete scan mode.

Optical Density

Same as Transmittance mode except that the final graph is displayed with an optical density scale (-log₁₀(T)).

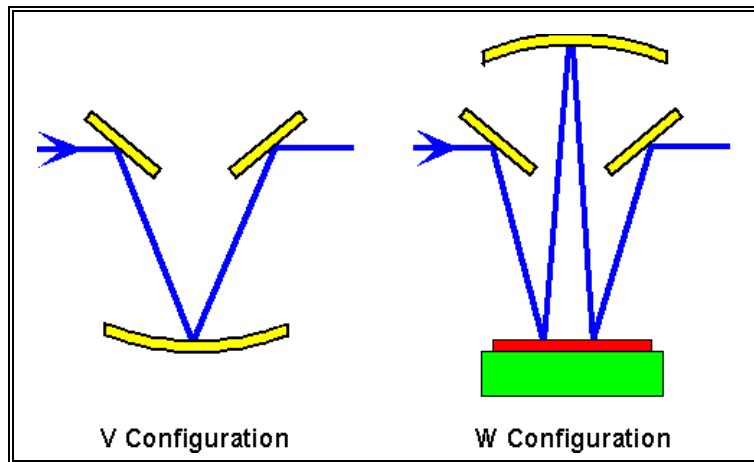

VW Reflectance Attachment (not to scale)

V Reflectance

Single bounce reflectance attachment. An optic with known reflectance, typically an uncoated substrate, is placed on the reflectance attachment and scanned in Reference mode. The part is then removed and a coated part is inserted in the same position for the Sample scan. Accuracy is excellent for antireflection coatings.

VW Reflectance

Multiple bounce reflectance attachment. The Reference scan corresponds to the attachment set in 'V' configuration. The Sample scan corresponds to 'W' configuration. This technique is most accurate for high reflectors and is not recommended for AR coatings.

Wavelength List

Setup...Wavelength List...Edit

The Wavelength List editor creates and edits custom lists of scan wavelengths for Discrete Scan mode. This is useful when measuring laser mirrors and filters at discrete wavelengths. The maximum number of entries is the same as the maximum number of Sample data points specified in **Configuration...Capacity**.

Use **Edit...Generate** to add regularly spaced new wavelengths to the list. Use **Edit...Paste** to paste an Excel-generated column into the editor.

A list must be stored on disk before it can actually be used in a MEASURE scan. Be sure to set Scan Type to Discrete in Scan Method 1B and enter the file name under List in Scan Method 3B.

The list can also be used for interpolating digitized data (**Spectra...Convert Table**) when the SummaSketch digitizer is the input device.

Wavelength List Generator

from Wavelength List editor: Edit...Generate

The Wavelength Generator automatically inserts a table of wavelengths into the Wavelength List editor. Use it repeatedly to enter wavelengths over various ranges. This could be useful when scanning over blocking and bandpass zones where different intervals are appropriate for each region.

Interval<0 generates a list spaced inversely in wavelength. For example: 400-1200 X -10 nm. The spacing is 10 nm at 400 nm and increases to 30 nm at 1200 nm.

Spectra Menu

Data Table

Examine the measured spectrum. Disabled if there is no data to view. The table also calculates minimum, average and maximum values over a selected range. Click the column title to select the entire column.

Clear Data

Clear current spectral data from memory.

Smooth Data

Interactively set parameters for Moving Average (sometimes called boxcar or block average) or Savitzky-Golay (less smoothing but less spectral distortion) smoothing. Baseline and Reference scans use MA, while Sample scans utilize MA or S-G. MA is recommended for most purposes; S-G is recommended for sharp spectral peaks or edges.

***Smoothing averages data over adjacent wavelengths.
Smoothed data is not original data and may not be acceptable.
The interval must be small enough to retain spectral features.***

Auto Smooth

Check to automatically smooth Baseline, Reference and Sample scans using values set in the Smooth Data dialog. Before enabling, use the interactive Smooth Data dialog to verify that smoothing retains spectral features. This capability is especially useful for antireflection coatings.

Users who require different smoothing parameters for Baseline, Reference, and Sample scans can utilize BASIC Sub DataSmooth.

Copy/Paste Data

Transfer spectral data to and from other Windows applications via the clipboard.

DDE...Import/Export

Transfer spectral data to and from other Windows applications via DDE (dynamic data exchange).

Quick Save

Stores the current spectrum as "work.csv" which can then be opened in Excel and copied to an appropriate worksheet. Close "work.csv" before returning to MEASURE and repeating the procedure.

Auto Save OFF/ON

Check to automatically bring up the File Save As screen upon completing a scan. Excel models which control disk file storage can ensure that Auto Save is off with DDE command AUTOSAVE 0.

Auto Backup OFF/ON

Check to enable automatic backup of Sample scans. Clicking the Backup button displays the Spectra Backup Recorder. Up to 9999 scans are saved in C:\Winfilm\SpCache with the most recent first. Auto Backup is not available in second and subsequent instances of MEASURE.

In the Recorder click **Edit...Comment** to add or edit comments and check **Auto Comment** to automatically activate comment input. Comments may also be edited by right clicking on a row. A left click (or Enter) opens and plots the spectrum. Multiple rows are cleared by highlighting and pressing Delete; File menu commands also delete rows.

Convert Table

Using linear interpolation, convert an irregularly spaced tablet-digitized spectrum into a spectrum with regularly spaced wavelengths defined in Scan Method 3B - Measurement Range.

This is especially useful for averages or color measurements which are defined over particular wavelength intervals.

Data Format

Clipboard

When examined with a text editor, sample transmittance data copied to the Windows clipboard appears as follows:

400	0	0.9876
450	0	0.9899
500	0	0.7891

Similarly, for Sample reflectance data:

400	0.0124	0
450	0.0111	0
500	0.2119	0

The first column is wavelength in nanometers followed by reflectance (0-1) and transmittance (0-1). Since we only measure reflectance or transmittance in MEASURE, the unmeasured quantity is set equal to zero. Data is TAB (ASCII 9) and CRLF delimited (ASCII 13 + ASCII 10) as follows:

```
400TAB0TAB0.9876CRLF
450TAB0TAB0.9899CRLF
```

Two-column data (wavelength and reflectance OR transmittance) can also be pasted. Data is pasted as reflectance or transmittance depending on graph axes setting. Uncheck **DESIGN Format** to copy in two-column format.

DDE

Data format is the same as tab-separated clipboard format discussed above. Data is transferred to a three column named cell block.

Format Options

As described above, spectra are normally copied and pasted with wavelength in nm. Check **Current units** to copy and paste spectra with the Wavelength Units currently specified in **Setup...Scan Method**. Normally reflectance and transmittance values are 0-1. Check **R & T in %** to change this to percent.

There are four file formats for loading and saving spectra. The first two file types are saved in ASCII format and can be read with a text editor. **.CSV** (comma-separated values) is MEASURE's default mode. **JCAMP** is a 'standard' which offers compatibility with spectroscopy software. **JCAMP + PerkinElmer compatible** should be used when saving PE Spectrum 2000 JCAMP files. The JCAMP standard is published in Robert S. McDonald and Paul A. Wilks Jr., *Applied Spectroscopy* **42**, 151 (1988).

Some programs deviate from published JCAMP standards or provide incomplete support. Programs frequently fail to support unequally-spaced wavelength data. Users who discover an incompatible JCAMP variation should contact FTG Software.

The third file format is binary .spc. This provides compatibility with Galactic Industries' *GRAMS* software. The fourth format is Excel .xls (Version 2.1). Excel files can be opened by Excel 97-2007.

Check **Combine reflectance and transmittance data** to keep both data arrays in memory for copying to the clipboard or storing on disk. Most importantly, both scans must have the same wavelength spacing. File format options are stored in the Scan Method.

.csv Format (File Open/Save)

When examined with a text editor, a FilmStar MEASURE .csv file resembles the following (transmittance):

```
"FilmStar .csv format example"  
31  
450, .9975317  
460, .9985523  
470, .9986734  
etc.
```

The first line is an optional description (50 characters maximum); the line is included even if the description is blank. The second line is the number of spectral points. The third and subsequent lines are wavelength (nm), reflectance (0-1) or transmittance (0-1). If *For Excel* is checked the following is obtained:

```
450,0.9975313  
460,0.9985526  
470,0.9986742  
etc.
```

In Europe, users often set their computer's number settings (Control Panel Regional Settings) as follows: decimal symbol ",", digit grouping symbol (thousands separator) ".", list separator ";". In this case the Excel file looks like the following:

```
450;0,9975317  
460;0,9985523  
470;0,9986734  
etc.
```

JCAMP and FilmStar .csv formats do not change when European number notation is used. Two-column data (wavelength and reflectance OR transmittance) can also be opened. Data is loaded as reflectance or transmittance depending on graph axes setting.

.xls (Excel) Format (File Open/Save)

Excel .xls format eliminates problems associated with .csv. While spectra can be opened in any version of Excel, FilmStar can only open FilmStar-created .xls spectra. Excel is not required.

W (nm)	%R
450	0.2528
460	0.146188
470	0.13243
480	0.15352

Users with more complex requirements, for example exporting multiple spectra to a single Excel file, can utilize a FilmStar BASIC macro. In that case, however, Excel must be installed.

Standard Data Editor

Spectra...Data Editor

This editor enables users to input Standard data from published tables. The editor is only available when Standard data is specified in **Spectra...Data Type**. The dialog box becomes a data viewer when other data types are specified. (To help maintain data integrity MEASURE does not permit users to edit scanned data.) Standard data can also be pasted from the clipboard (<Ctrl+V>) or loaded from Excel-compatible files.

Using the grid control, users can enter the same values in all or part of the reflectance or transmittance column by highlighting the range before typing values. Select the entire column by clicking the column title. For example to enter 4.2% in all rows, click the title '% Refl' and type '4.2'. Entries can be deleted by selecting entire rows and pressing .

Tablet Procedures

The Mpe983.exe version of MEASURE supports data entry with Summagraphics SummaSketch digitizer tablets.

Strip-Chart Alignment - 1

Tape the strip-chart spectrum to the tablet surface and enter wavelengths corresponding to left and right boundaries. The strip-chart need not be mounted perfectly parallel to the tablet edge. If the chart is bigger than the tablet, it will be possible to acquire data as a series of separate scans.

Strip-Chart Alignment - 2

Locate and enter points in the following order:

1. Lower Left
2. Lower Right
3. Upper Left

These points must form a right angle; if there is too much deviation an error message is issued and it is necessary to restart the alignment procedure.

Data Acquisition

Following alignment, the screen is redrawn and a crosshair cursor follows the position of the tablet stylus. Press the stylus (or cursor button 1) to enter a point. Press <F3> (or cursor button 3) to delete the last entered point. Continually press <F3> to delete all points. To select a particular point for deletion, locate it with the screen crosshair and press <F4> (or cursor button 4) to erase the point. If MEASURE cannot identify the point, try again.

When all points have been entered, press <Esc> or stylus/cursor button 2 to quit. The data can still be edited or more points added by restarting the scan

procedure and NOT clearing the current data stored in memory. The strip-chart must be realigned after being moved to encompass a new part of the spectrum.

Enter data points following slopes and peaks - enter more points where the spectrum changes rapidly. Use **Spectra...Convert Table <Ctrl+F8>** to convert measured data into regularly spaced wavelength intervals.

Tools Menu

This menu provides access to the following programmable modules: FilmStar Workbook (page 49), FSPlot Graphing Module (page 52), FilmStar BASIC (page 33). Complying with the usual Windows location for print commands, the Report Generator (page 57) is accessed from the File Menu.

Macro Commands

Tools...Macro Commands <Ctrl+Z>

A FilmStar macro is a series of commands that can be executed by FilmStar itself or by other Windows applications by dynamic data exchange (DDE). While DDE is older technology largely supplanted by FilmStar-supported ActiveX, it provides the means to communicate with DDE-compliant 16-bit applications. The following section provides a complete command list.

The Macro Commands dialog lists up to six macro descriptions and corresponding commands. The most important macro commands are *BasOpen* (open a BASIC program for editing) and *BasRun* (run a program). Commands in the **Edit Menu** simplify data entry by locating BASIC (.bas) files. Macro descriptions are then used in both the Tools Menu and in the Macro Buttons toolbar where they appear as tooltip text.

Macro Reference (DDE)

Programming skills in BASIC, Excel or other Windows languages may be required to implement topics discussed below. Please contact FTG Software Associates for assistance.

Dynamic data exchange (DDE) is a means of importing and exporting data across Windows applications. While superseded by 32-bit object-oriented methods (supported by FilmStar), DDE links 16 and 32-bit programs as well as 32-bit programs which do not support objects. Select **Spectra...DDE...Import** or **Export <Shift+Ctrl+F8>** to transfer spectral data.

Import/Export

In Windows jargon these are actually Link Request and Link Poke events. MEASURE uses 'cold' links. In a 'hot' link data is exchanged automatically.

Options

Each option includes a Topic and an Item. These are automatically stored on disk on exiting MEASURE. Topics for Microsoft Windows applications are as follows:

Application	DDE application name
Microsoft Excel	Excel
Microsoft Word for Windows	WinWord

In Excel the topic is 'Excel|' plus the name of the worksheet. The item 'spectrum' is the named range into which data is transferred:

Topic	excel e:\excel\spectra\analyze.xls
Item	spectrum

Consult the appropriate reference manual for DDE application names for other Windows programs.

Macro Commands

MEASURE supports another DDE facility. It is possible to load a Scan Method, execute the Auto Zero and Initialize commands, scan and store Sample, Baseline and Reference data files remotely via Excel's EXECUTE function. The same commands are used with the built-in command macro facility and with macros using the BASIC Macro function.

FilmStar BASIC (page 33) duplicates most macro commands and has the advantage of displaying syntax in an object browser. FilmStar BASIC also provides a large set of additional commands.

These commands circumvent MEASURE's normal error-checking. Note that DataSave and ReportSave overwrite files with the same name. *Some commands are not supported by some instruments.* Capitalization is not important. Each command terminates with a semicolon. In the list below Italics indicate comments and are not part of the command.

AutoExport...Enable/Disable auto DDE export function

```
AutoExport 0;  disable
AutoExport -1; enable
```

AutoSave...Enable/Disable auto save function

```
AutoSave 0;    disable
AutoSave -1;   enable
```

AutoZero (PE)...Perform autozero and background correction

```
AutoZero 420 780 240;  (420 - 780 nm, 240 nm/min)
```

AxesCopy...Copy graph axes settings to clipboard. Excel-compatible format equivalent to Edit...Copy command in graph axes editor.

```
AxesCopy;
```

AxesDraw...New graph axes

```
AxesDraw;
```

AxesSubTitle...Specify FSPlot subtitle.

```
AxesSubTitle This is FSPlot subtitle (small font);
```

AxesTitle...Specify title in main graph and FSPlot.

```
AxesTitle This is main graph and FSPlot title;
```

BaselineTest...Load Baseline spectral file to use in test mode

```
BaselineTest BASE1;
```

BasChain...Immediately run FilmStar BASIC program from within another BASIC program.

```
BasChain c:\winfilm\basic32\fnun.bas;
```

BasOpen...Open FilmStar BASIC program and display the code in the BASIC IDE. Do not execute this command from BASIC!

```
BasOpen c:\winfilm\basic32\test.bas;
```

BasRun...Immediately run FilmStar BASIC program without displaying the IDE. Do not execute this command from BASIC!

```
BasRun c:\winfilm\basic32\fnun.bas;
```

BasWindow...Set BASIC window state: 0 normal, 1 minimized, 2 maximized. This is useful if you want to get the window out of the way while running BASIC programs.

```
BasWindow 0;
```

Blank...Scan a blank spectrum (HP 8453 only)

Busy...Turn hourglass cursor off/on. This may be required if the program does not provide the correct cursor automatically.

```
Busy 0; default cursor  
Busy 1; hourglass cursor
```

CIEWindow...Set CIE window state: 0 normal, 1 minimized, 2 maximized.

```
CieWindow 2; maximize CIE Window
```

DataClear...Clear current spectrum from memory

```
DataClear;
```

DataConvert...Convert data table to new wavelength interval as specified in Measurement Range. Same as **<Convert Table>**.

```
DataConvert;
```

DataConvertRange...Convert (interpolate) current spectrum to specified range (min max interval). Useful for reducing number of data points.

```
DataConvertRange 380 780 5;  
DataConvertRange 400 800 -2;
```

DataCopy...Copy spectrum to the clipboard

```
DataCopy;
```

DataDesc...Description for spectral data (50 char max)

```
DataDesc This is the description;
```

DataExport...Export spectrum via DDE

```
DataExport;
```

DataExportItem...Change DDE export item. In Excel this corresponds to the named range

```
DataExportItem spectrum;
```

DataExportTopic...Change DDE export topic. In Excel 5.0 this corresponds to 'excel' & pipe character (vertical line) & workbook name

```
DataExportTopic excel|book1; or  
DataExportTopic excel|analyze.xls;
```

DataOpen...Open spectral data file from disk. Adding an extension specifies data format. If a path is not included the default path is used. See **DataPath** and **TypeDataFile**.

```
DataOpen test1;  
DataOpen c:\winfilm\spectra\test1;  
DataOpen c:\winfilm\spectra\test1.csv;  
DataOpen c:\winfilm\spectra\test1.dx;  
DataOpen c:\winfilm\spectra\test1.spc;
```

DataOpenDialog...Open spectrum dialog box

```
DataOpenDialog;
```

DataPaste...Paste data from clipboard

```
DataPaste;
```

DataPath...Change default data path

```
DataPath c:\winfilm\spectra\reflect;
```

DataSave...Save spectrum to disk. Adding an extension specifies data type. If a path is not included the default path is used. See **DataPath** and **TypeDataFile**.

```
DataSave test1;  
DataSave c:\winfilm\spectra\test1;  
DataSave c:\winfilm\spectra\test1.csv;  
DataSave c:\winfilm\spectra\test1.dx;  
DataSave c:\winfilm\spectra\test1.spc;
```

DataSaveAsDialog...Bring up spectrum *Save As* dialog.

```
DataSaveAsDialog;
```

DataSaveReadOnly...Save spectrum to disk with read-only attribute.

```
DataSaveReadOnly test1;
```

DataSmooth...Smooth equally spaced data with Moving Average or Savitzky-Golay filter. Essentially, Moving Average is better at reducing noise while S-G is better at preserving structure and peak heights. An odd number of points is required; S-G polynomial orders can be 2, 4, 6. Moving Average is always utilized for Baseline and Reference spectra.

```
DataSmooth 1 31 0;   moving average, 31 points  
DataSmooth 2 31 2;   S-G, 31 points, smoothing  
                    polynomial order 2  
DataSmooth 2 45 4;   S-G, 45 points, smoothing  
                    polynomial order 4
```

Smoothed data is not original and may not be acceptable!

DataType...Select Sample, Baseline, Reference, Standard. Background is also available in PE Spectrum 2000 operation.

```
DataType sample;
```

DefaultPath...Change paths listed in **File...Configuration...Directories** corresponding to **Scan Method**, **Sample Spectra** and **Reference Spectra**. All three paths, separated by spaces, are entered in one command and

any directories changed by **MethodPath** or **DataPath** are changed back to defaults.

```
DefaultPath c:\winfilm\params c:\winfilm\sample  
c:\winfilm\refrnce;
```

To leave one or more paths unchanged, substitute the word **same** for file name as follows

```
DefaultPath same c:\winfilm\sample same;
```

GotoWave...Slew to wavelength in nanometers (wavenumber in 1/cm for PE 88x/983/983G).

```
GotoWave 550;
```

Initialize...Initialize spectrophotometer (PE 2/5/7/9/19 only)

```
Initialize;
```

LineColor...Change line color as follows: black, Red, Yellow, Blue, Green, Magenta, Cyan, White

```
LineColor R;
```

MainWindow...Set the main program window state: 0 normal, 1 minimized, 2 maximized.

```
MainWindow 1; minimize main program window
```

MethodOpen...Load Scan Method from disk

```
MethodOpen reflcie;
```

MethodPath...Change Scan Method directory

```
MethodPath c:\winfilm\measure\lambda9;
```

MultScan...Perform multiple scans without plotting. Resulting data is the average. (Not available in Mpe950.exe, Mpe1050.exe)

```
MultScan 10; scan 10 times
```

MultScanPlot...Same as MultScan with data being displayed while scanning. Resulting data is the average. (Not available in Mpe950.exe, Mpe1050.exe)

```
MultScanPlot 5; scan 5 times
```

Pe19SpOpen...Open PerkinElmer .sp spectrum

```
Pe19SpOpen;
```

PlotPoint...Plot a single spectral data point .

```
PlotPoint 425, 54.8; plot point at 425 nm, 54.8%
```

PlotWindow...Set FSPlot module window state: 0 normal, 1 minimized, 2 maximized.

```
PlotWindow 2; maximize plot module window
```

Prompt...Issue a prompt with OK button

```
Prompt Insert sample|What to do next;
```

PromptCancel...Issue a prompt with OK and Cancel buttons. Pressing Cancel provides a means to exit a multi-command macro.

PromptCancel Insert sample|What to do next;Fred;

ReferenceTest...Load Reference spectral data to use in test mode

ReferenceTest ref1;

Replot...(Re)plot current spectrum

Replot;

ReportPrint (or PrintReport)...Print the current report without displaying it. Same as File...Quick Print Report. Use ReportShow to display the Report Generator dialog before printing.

ReportPrint;

ReportSave (or SaveReport)...Save report as a binary printer file. The report is not displayed. Include path and extension.

ReportSave c:\winfilm\reports\test1.prt;

ReportShow (ShowReport)...Preview report and optionally print it.

ReportShow;

SampleTest...Load Sample spectral data to use in test mode

SampleTest smp1;

Scan...Acquire data

Scan;

ScanPlot...Acquire data while showing plot

ScanPlot;

Shell...Run a DOS or Windows program. It is not necessary to include the path if the program is in the FilmStar MEASURE program subdirectory. If the extension is left blank, an .exe file is assumed.

Shell d:\dos\test.bat;

Shutter...Insert/Remove beam shutter (983/983G only)

Shutter 1; *insert*

Shutter 0; *remove*

StatusLabel...Display message in status label at screen lower left

StatusLabel Visit Princeton today;

StatusLabel; (clears label)

TypeDataCopy...Copy and paste (DDE import/export) spectral data using R/T = 0-100% instead of 0-1. This can also be selected manually in

Spectra...Format Options.

TypeDataCopy 0; *R/T 0-1*

TypeDataCopy 1; *R/T 0-100%*

TypeDataFile...Open and save spectral data using .csv or JCAMP format. This can also be selected manually in **Spectra...Format Options**. JCAMP is a 'standard' spectroscopy file format and provides a link to other software packages. Clipboard and .csv data can be created in DESIGN three column format (Wave, R, T) or simpler two column format (Wave, R or T).

```
TypeDataFile 0;      .csv ASCII format
TypeDataFile 1;      JCAMP format
TypeDataFile 2;      .spc GRAMS/386 format
TypeDataFile 11;     JCAMP, PE compatible
TypeDataFile 100;    .csv for Excel
TypeDataFile 1000;   .csv 2 columns
TypeDataFile 1100;   .csv for Excel 2 columns
```

TypeWaveCopy...Copy and paste (DDE import/export) spectral data using current wavelength units rather than nanometers. This can also be selected manually in **Spectra...Format Options**.

```
TypeWaveCopy 0;     wavelength in nanometers
TypeWaveCopy 1;     wavelength in user-specified units
```

WbActivate...Activate Workbook module. The same command is also provided in FilmStar BASIC.

```
WbActivate;
```

WbSetName...(Re)assign Workbook defined name. Especially useful for moving DataMarker in complex models requiring multiple spectral ranges. Reassigning DataMarker resets data looping.

```
WbSetName DataMarker $A$100;
```

WbWindow...Set Workbook window state: 0 normal, 1 minimized, 2 maximized.

```
WbWindow 2;    maximize plot module Window
```

Each command is followed by a semicolon (;). Commands may be grouped or sent in separate EXECUTE commands. *Do not use semicolons in text strings!* Spaces separate parameters in some commands.

These following DDE examples are included for historic reasons! Anyone starting a new project should communicate with ActiveX instead.

The following Excel macro loads Scan Method file TRNSCIE, sets Data Type to Sample, scans the sample and copies the spectrum to the clipboard. The EXECUTE command is one macro statement on one line. Change "MPE983" to correspond to different versions of MEASURE.

The command string in DDEExecute must be surrounded by square brackets. The DDEExecute command is one macro statement on one line.

```
Sub Main
  ch = DDEInitiate("MPE983","Main")
  DDEExecute ch, "[StatusLabel Please wait;
  ParamOpen TRNSCIE;DataType SAMPLE;Scan;
  DataCopy;StatusLabel Done;]"
  DDETerminate ch
End Sub
```

Macro command 'Fred' is useful for making sure that things work!

```

Sub Main
  Ch = DDEInitiate("MPE983","Main")
  DDEExecute Ch, "[Fred;]"
  DDETerminate Ch
End Sub

```

These commands are especially useful when Excel is 'in-charge' of spectral data file operations. Commands can also be sent from the Workbook and from **Evaluate...Macro <Shift+F1...F6>**.

FilmStar BASIC

FilmStar BASIC is a development environment for customizing FilmStar. Using Sax Basic, FilmStar BASIC adds the special commands and keywords discussed in this section. Two macro commands are supported: BasOpen and BasRun.

The FilmStar BASIC language is nearly 100% compatible with Microsoft VBA (Visual Basic for Applications). The IDE (Integrated Development Environment) (**Tools...BASIC Editor <F6>**) provides means to edit and test BASIC programs.

BASIC Code Generators

Users will find *Create BASIC Code* commands in three places: Report Generator (File menu), FSPlot Module (File menu and Setup...Annotations menu). This enables advanced users to define reports and graphs in BASIC programs. In this way consistency is maintained even if users purposefully or accidentally modify report and graph settings.

The trick to developing Reports or Annotations containing computed values is to create the BASIC code and then replace constants with functions. As an example, the following Annotation code (vertical line at 1640 nm)

```
"\vline 1640.00,5,|b 1640.00 nm,16711680;0" & vbCrLf
```

would be replaced by

```
"\vline " & format$(wc, "0.00") & ",5,|b " & _
Format$(wc, "0.00") & " nm,16711680;0" & vbCrLf
```

where *wc* is the center wavelength computed by BASIC *Sub BandCtr*, as in BASIC program *BandWidthPlot.bas*.

FilmStar MEASURE Extensions

Summary documentation for FilmStar extensions is provided in the BASIC editor (IDE). Click the Browse Object icon.

Variables can be transferred to and from MEASURE to FilmStar BASIC for various calculations. In addition a number of functions and subroutines are available. Capitalization is not important in the following:

Property AutoExport As Boolean...Enable automatic DDE export after sample scan

```
AutoExport = True
```

Property AutoSave As Boolean...Enable automatic save dialog after sample scan

AutoSave = True

Sub AutoZero(wMin!, wMax!, wInt!)...Perform autozero and background correction (appropriate PE models)

AutoZero 400, 800, 2

Sub AveCalc(yMin!, yMax!, yAve!, Optional wMin!, Optional wMax!)... Returns min, max, average (in %). Optional wMin, wMax (in current wavelength units) restricts calculation to a sub-range.

AveCalc rMin, rMax, rAve ' entire measurement range
AveCalc rMin, rMax, rAve, 550, 650 ' partial range

Sub AxesCopy...Copy axes settings to clipboard.

AxesCopy

Sub AxesDraw...Draw new graph axes.

AxesDraw

Sub BandCtr(wMin!, wMax!, wCtr!, kErr As Boolean, Optional kType%)... Compute bandpass mean center wavelength *wCtr* in range wMin to Wmax; set kType=1 for average center wavelength; returns kErr=True if error.

BandCtr 400, 800, wCtr, kErr

Sub BandMax(wMin!, wMax!, bMax!, kErr As Boolean)...Compute maximum bandpass value *bmax* in range wMin to Wmax; returns kErr=True if error.

BandMax 400, 800, bMax, kErr

Sub BandMaxWave(wMin!, wMax!, wPeak!, kErr As Boolean)...Returns wavelength corresponding to the maximum bandpass value in range wMin to Wmax; returns kErr=True if error. *The value may be inaccurate if the wavelength spacing is too coarse.*

BandMaxWave 400, 800, wPeak, kErr

Sub BandWidth(Level!, wMin!, wMax!, bw!, kErr As Boolean)...Compute bandwidth *bw* at a given % Level within range wMin to wMax; returns kErr=True if error.

BandWidth 50, 400, 800, bw, kErr ' 50% bandwidth
BandWidth 10, 400, 800, bw, kErr ' 10% bandwidth

Sub BasActivate...Return focus to BASIC's IDE (integrated development environment).

BasActivate

Sub BasChain(file\$)...Immediately run BASIC program from current program.

BasChain "c:\winfilm\basic32\eval1.bas"

Property BasText\$(0)...BasText\$(15)...Set text variable for use in the Report Generator with formatting commands <<BasText>> and <<BasBlock>>. Text can be a fragment or a block of paragraphs. *Note that this is slightly different from the 16 bit version!*

BasText(0) = "Welcome to FilmStar Programming"

Sub Busy(k As Boolean)...Turn hourglass cursor on/off

Busy False ' turn off hourglass cursor

Cary Functions...See Carydlls.hlp (<http://ftgsoftware.com/docs/carydlls.zip>)

Property CieParams\$...Get string showing CIE parameters. The same string is displayed in the CIE Graph Axes title.

s\$ = CieParams ' returns "1931 x,y (2°) Illuminant A"

Sub CieWindow(kState%)...Set CIE window state: 0 normal, 1 min, 2 max

CieWindow 2

Sub ConfigOpen...Reload configuration from measure.ini.

ConfigOpen

Sub DataAutoSmooth(k as Boolean, Optional kType%, Optional nPoints%, Optional kPoly%)...Enable/disable Auto Smooth capability (Spectra menu); optionally adjust smoothing parameters.

Sub DataBackup(Optional Comment\$)...Add spectrum and optional comment to Spectra Backup Recorder. Auto Backup does not need to be enabled.

Sub DataClear...Erase current spectrum.

DataClear

Sub DataConvert(Optional wMin!, Optional wMax!, Optional wInt!)...Convert spectrum range to current axes settings; optionally specify min, max and interval. If wmin=0 then use current graph axes settings

DataConvert ' use graph axes settings

DataConvert 400,600,2 ' convert data to 400-600x2 array

Sub DataConvertList(List\$)...Convert (interpolate) current spectrum to specified Wavelength List file.

DataConvertList "LBL Window" ' default directory

DataConvertList "c:\winfilm\wave\LBL Window.wls"

Sub DataCopy...Copy spectrum to clipboard in Excel format.

DataCopy

Sub DataDeriv(kOrder%, nPoints%, kPoly%)...Compute derivative spectrum using Savitzky-Golay.

DataDeriv 4,11,2

Sub DataExport(Optional topic\$, Optional item\$)...Export data via DDE; optionally specify new topic and/or item.

DataExport

Sub DataPaste...Paste data from clipboard.

DataPaste

Sub DataSmooth(Optional kType%, Optional nPoints%, Optional kPoly%)...Smooth equally spaced data: kType=1 Moving Average, 2 Savitzky-Golay filter; kPoints is odd number; kPoly is S-G polynomial order 2,4,6. Moving average is always used for Baseline and Reference scans.

DataSmooth ' use values from Smooth Data dialog

DataSmooth 2,11,4

Property DataType%...Specify spectral data type: 1 sample, 2 baseline, 3 reference, 4 standard, 5 background (FTIR)

```
DataType = 3
```

Sub DefaultPath(Optional pParam\$, Optional pSample\$, Optional pReference\$)...Change some or all default paths listed in configuration dialog; restore current directories to default.

```
DefaultPath "c:\dwdm\test004" ' change spectra path
```

Sub Disconnect...Disconnect spectrophotometer from server (Mpe950.exe, Mpe19AX.exe)

```
Disconnect
```

Sub DispBox(text\$, icon%, title\$)...Display a message box without buttons. This is useful for status messages when no response is required. Use the following icon numbers: 16-Stop, 32-Question, 48-Attention, 64-Information. Use the BASIC MsgBox instruction when a user response is required.

```
DispBox "Waiting for stabilization", 48, "Heater"  
Wait 10 ' wait 10 seconds  
DispBox "", 0, "" ' remove the box
```

Sub Display(text\$, title\$, wd%, ht%, FontName\$, FontSize!, FontBold%, Optional Color&)... Display a multiline text box in a dialog box with width wd% and height ht% in twips. Print and Copy buttons are suppressed when Color is greater than zero.

```
Display "FTG Software Associates", "Princeton, New  
Jersey", 5000, 3000, "Arial", 18, 1, RGB(0, 192, 0)
```

Sub EdgeCalc(Level!, wMin!, wMax!, wEdge!, yEdge!, kErr As Boolean)...Compute cuton/cutoff wavelength wEdge and R/T value yEdge at a given % Level within range wMin to wMax; returns kErr=True if error.

```
EdgeCalc 50, 400, 800, wEdge, yEdge, kErr ' 50% cut
```

Property FileDescription\$(k%)...Assign/get file description: k=1 Spectral Data, 2 Scan Method.

```
S$ = FileDescription(1)  
FileDescription(1)= "100% yield DWDm spectrum"
```

Function FileOpen(file\$, Optional k%) As Boolean...Open file; optional path; use extension or k to specify type: k=1 Spectral Data (.csv, .dx, .spe), 2 Scan Method:

```
FileOpen "c:\winfilm\data\spec1.csv"  
FileOpen "c:\winfilm\data\spec1", 1  
FileOpen "spec1.csv", 1 ' default path used  
FileOpen "spec1", 1 ' " " " "  
  
If Not FileOpen("spec1.csv") Then  
    MsgBox "Bad file name",vbCritical,"Open"  
    Exit Sub  
End If
```

Property FilePath\$(k%)...Assign/get current file path: k=1 to 2 as above

```
s$ = FilePath(1)  
FilePath(1) = "c:\dwdm\spectra"
```

Function FilePropsGet(FileName\$, Title\$, Subject\$, Author\$, LastAuthor\$, Keywords\$, Comment\$, ReadOnly as Boolean) as Boolean...Returns NTFS properties for any file. Include file name with path and extension.

Sub FilePropsList(files\$)...Returns array of spectra file names displayed in the File Properties List dialog. Users can then use FileOpen to open and analyze similar spectra.

```
Sub Main
  Dim k&, files$()
  On Error GoTo NoList ' important
  FilePropsList files$()
  For k = 1 To UBound(files$)
    Debug.Print files$(k)
  Next k
NoList:
  Exit Sub
End Sub
```

Function FilePropsSet(Title\$, Comment\$, Optional FileName\$, Optional User\$, Optional Subject\$, Optional Keywords\$) As Boolean...Adds NTFS file properties to Sample spectra files. The following values are utilized when optional fields are blank or missing:

```
File: Current Sample spectral data file name
User: User Name in File...Configuration dialog
Subject: "FilmStar MEASURE Spectrum"
Keywords: "FTG FilmStar MEASURE Spectrum (.csv/.dx/.spc/.xls)"

FilePropsSet "4 Layer BBAR", "Average < 0.1%"
```

Function FileSave(Optional file\$, Optional k%) As Boolean...Save file; optional path; use file extension or k to specify type: k=1 Spectral Data (.csv, .dx, .spc), k>1 reserved for future use. All of the following will work:

```
FileSave ' Brings up Save As dialog
FileSave "c:\Winfilm\Spectra\spec1.csv"
FileSave "c:\Winfilm\Spectra\spec1", 1
FileSave "spec1.csv" ' default path used
FileSave "spec1" ' default path used

If Not FileSave("c:\Winfilm\Spectra\spec1.csv") Then
  MsgBox "Could not save",vbCritical,"Save"
Exit Sub
End If
```

Function fMsgBox%(Text\$, Type%, Title\$)...Similar to BASIC's MsgBox but modal within MEASURE. This prevents covering the dialog by clicking on the MEASURE window. Can be automatically closed; see MsgBoxTimer. Type = 6 deletes buttons and closes the box in 5 seconds unless MsgBoxTimer is set for a longer interval.

```
k = fMsgBox("Do you want to proceed?", 36, "BASIC")
```

Property Footer\$...Assign/get report footer.

```
Footer = "Text at bottom of report"
s$ = Footer
```

Sub GetCie(x!, y!, yy!, Optional yp!) ...calculate CIE color coordinate triplet (x, y, Y), (u, v, L) or (a*, b*, L*) depending on CIE settings (stored with Scan Method). Optional yp returns photopic response (same as yy if CIE x, y specified) independent of CIE settings. The spectrum must contain 380-780 x 1 nm or 380-780 x 5 nm data

```
GetCie x, y, yy
```

Sub GetCieTri(X!, Y!, Z!, Optional Mode\$) .. calculate CIE tristimulus values. Optional Mode = R or T overrides current program setting.

```
GetCieTri X, Y, Z
```

Function gMsgBox%(Text\$, Type%, Title\$, Optional gFile\$, Optional gCaption\$, Optional HtAdj%, Optional WdAdj%, Optional kTop%, Optional kLeft%)...Similar to MsgBox with the possibility of including a GIF or JPG bitmap (gFile\$) and caption (gCaption\$). The dialog auto-adjusts to picture size with HtAdj/WdAdj providing further height/width adjustments in twips. (1 pixel = 15 twips. Increasing height or width allows a longer message.) kTop and kLeft (twips) make it possible to specify the dialog's position.

```
If fMsgPic("Are results similar to graph?", vbYesNo, _  
"Verify", "C:\Winfilm\Pics\Bandpass.gif", "Bandpass") _  
= vbNo Then End
```

Note that several parameters are optional. Care must be taken to ensure that the graphic is not too big for the dialog. Use a bitmap editor to reduce its size as needed and convert FSPlot PNG files to GIF. Can be automatically closed; see MsgBoxTimer. Type = 6 eliminates buttons and closes the message box in 5 seconds unless MsgBoxTimer is set for a longer interval.

Sub GotoWave(wave!) ...Slew to wavelength in nanometers (wavenumber in 1/cm for PE 88x/983/983G)

```
GotoWave 550
```

Property Header\$...Assign/get report header

```
Header = "Text at top of report"  
s$ = Header
```

Property hWndForm&...Get the Windows handle for the active form. This advanced function is used when calling modal DLL's.

```
k& = hWndForm ' returns handle to active form
```

Property IDDiskNum&...Returns hard disk (C drive) ID number

```
k& = IDDiskNum
```

Property IDModInfo\$...Returns Security ID Module information

```
s$ = IDModInfo
```

Function IniString\$(section\$, key\$)...Get user-defined initialization variable from measure.ini.

```
s$ = IniString$("Chuck Vogel", "LastFileName")
```

returns "WW098909" if the following is in measure.ini:

```
[Chuck Vogel]  
LastFileName=WW098909
```

Sub Initialize...Initialize (connect to server) spectrophotometer (NOTE: applies when Initialize command is in Setup menu)

Initialize

Sub LineColor(color\$)...Color\$=K black, B blue, G green, C cyan, R red, M magenta, Y yellow, W white

```
LineColor "R" ' red
```

Function Macro(text\$) As Boolean...Run macro commands from BASIC.

```
k = Macro("Scan;")
```

k returns False (0) if there was an error executing the macro. This function is no longer required as BASIC functions now duplicate macro commands.

Sub MainActivate...Return focus to MEASURE's Main Menu.

```
MainActivate
```

Sub MainEnabled(k as Boolean, Optional s\$)...Disable/enable main program window; use with caution; s\$ is displayed in toolbar

```
MainEnabled False, "Disabled"
```

Property MainEvents As Boolean...By default, running a program from the BASIC editor (IDE) enables FilmStar keyboard and mouse events. By default, running a program via macro command *basrun* disables FilmStar keyboard and mouse events. This behavior may be changed in a BASIC program by setting *MainEvents* true or false.

```
MainEvents = True ' respond to keyboard/mouse  
                ' default in IDE
```

```
MainEvents = False ' do not respond to keyboard/mouse  
                ' default when run without IDE
```

Setting *MainEvents = True* in a BASIC program run from *basrun* adds an **Abort BASIC** menu command which also aborts the current scan.

Sub MainWindow(kState%)...Set main window state: 0 normal, 1 min, 2 max.

```
MainWindow 0
```

Property MsgBoxTimer!...Set time interval for automatically pressing Enter in the fMsgBox, gMsgBox, sMsgBox message box if the user does nothing. Since the timer is disabled when the message box is closed, the *MsgBoxTimer* statement is required before each box containing a timer. The maximum value is 65 seconds.

```
Beep
```

```
MsgBoxTimer=15 '15 seconds timeout  
sMsgBox "Get a cup of coffee!", 48, "Working Hard"
```

Sub MultScan(nScans%, Optional Plot As Boolean)...Perform multiple scans; resulting data is average spectrum; set *Plot=True* to plot.

```
MultScan 10
```

Function PadString\$(text\$, length%, align%)...This function pads a string with spaces to return a string of given length. Spaces are added to the left (*align=0*) or right (*align=2*) or the string is centered (*align=1*). This function is useful for generating reports.

```
BasText$(0) = PadString$(format$(x!, "0.000"), 8, 0)
```

Sub Pe19SPopen...Open PerkinElmer Lambda 19 .sp (binary format) spectrum.

Pe19SPopen

Property PgmCaption\$...Get main MEASURE caption (title bar). This is required for Visual Basic's AppActivate method.

```
s$ = PgmCaption
```

Property PgmExe\$...Get the name of the FilmStar .EXE file. This can be useful when you want to use the same BASIC programs for DESIGN and MEASURE or for different instruments.

```
s$ = PgmExe ' returns "MPE983"
```

Property PgmPath\$...Get the name of the FilmStar program path. This is useful for opening Workbook files with WbOpen.

```
s$ = PgmPath ' returns "C:\WINFILM"
```

Sub PlotActivate...Activate the FSPlot Module.

```
PlotActivate
```

Sub PlotAnnotate(kShow As Boolean)...Turn FSPlot annotations on/off; must precede PlotActivate.

```
PlotAnnotate True ' turn on annotations
```

Property PlotAnnotation\$...(Formerly *Annotate*) Assign/get FSPlot Annotation string. Annotations are customized with BASIC's *Replace* function:

```
s$ = PlotAnnotation  
PlotAnnotation = Replace(s$, "SerNum", "45678", 1, -1)  
ReportPrint  
PlotAnnotation = s$ 'put back original
```

Property PlotAxesConfig%...(Formerly *PlotAxes*) Specify additional axes choices. Value can be generated in FSPlot Module.

```
PlotAxesConfig = 6
```

Property PlotAxesFont\$...Specify font for FSPlot axes

```
PlotAxesFont = "Poster Bodini"
```

Sub PlotClear...Clears all FSPlot graphs without closing the module.

```
PlotClear
```

Sub PlotClose...Close FSPlot (clears all graphs).

```
PlotClose
```

Plot Configuration Subroutines...FSPlot configuration includes a number of subroutines which need not be documented because the BASIC code is automatically generated via **File...Create BASIC Code** in the FSPlot Module.

```
PlotConfig, PlotSize, PlotTitleFont, PlotTitleSize, PlotLegendSize  
PlotAxesFont, PlotAxesLabelSize, PlotAxesNumberSize, PlotFontFixed  
PlotFontFixedSize, PlotAxesConfig, PlotEdgeSpace, PlotAxesSpace  
PlotColors, PlotBitmapMode, PlotTableColors
```

Sub PlotCopy(Optional kType%, Optional Zoom%)...Copy FSPlot image to clipboard; kType=0 metafile (default), 1 bitmap, 2 jpeg; zoom in % (default 100)

```
PlotCopy 1, 125 ' copy as bitmap 125%
PlotCopy ' copy as metafile
```

Sub PlotDAQ(kType%)...Plot acquired data in FSPlot; kType=1 baseline, 2 reference, 3 standard, 4 sample (raw).

```
PlotDAQ 3 ' plot reference data
```

Sub PlotDataCopy()...Copy FSPlot data to clipboard in Excel-compatible tab-separated format.

```
PlotDataCopy
```

Sub PlotDataOpen(Optional file\$)...Open FSPlot data. Specify a complete file name (path & ext) or leave blank to activate a file open dialog.

```
PlotDataOpen "c:\winfilm\spectra\filter.csv"
PlotDataOpen ' file dialog
```

Sub PlotDataPaste()...Paste tab-separated (Excel format) FSPlot data.

```
PlotDataPaste
```

Sub PlotDataSave(Optional file\$)...Save FSPlot data in Excel-compatible CSV format. Specify a complete file name (path & ext) or leave blank to activate a file save dialog.

```
PlotDataSave "c:\winfilm\spectra\filter.csv"
PlotDataSave ' file dialog
```

Property PlotLegend\$(1)...PlotLegend\$(12)...Set the text for FSPlot legends 1-12.

```
PlotLegend(1) = "Angle = 0°"
```

Property PlotLegendOn(k As Boolean)...Turn plot legends on or off.

```
PlotLegendOn False ' no plot legends
PlotLegendOn True ' use plot legends
```

Property PlotLegendSize%...FSPlot legend relative font size (50-150, 100 default)

```
PlotLegendSize = 110
```

Sub PlotNext...Add another graph to FSPlot window. Same as clicking the Plot button.

```
PlotNext
```

Sub PlotRun(Optional formula\$)...Run Plot Formula to modify FSPlot graphs. The formula should be thoroughly tested in the FSPlot Formulator before being used in FilmStar BASIC code. If *formula\$* is blank or missing the Plot Formula currently in memory is utilized.

```
PlotRun ' Run formula currently in memory
PlotRun "B=if(A>=425 & A<=515, 100*B, B)"
```

Sub PlotSave(file\$)...Save FSPlot graphs to disk as a windows metafile or bitmap. *Include the full path and optionally add .wmf, .bmp or .jpg extension.* If no extension, file type depends on selection in FSPlot Setup. Use this routine to generate reports with multiple FSPlot graphs.

```
PlotSave "d:\winfilm\save1"
```

When creating complex documents with a series of graphs to be plotted later in the Report Generator use the following idea:

```
PlotSize 8000, 6500, 75 ' set graph size
For i = 1 To 10
    ' code to get spectra
    PlotSave "d:\winfilm\psave" & format(i,"00")
Next i
```

Sub PlotSize(width%, height%, csize%)...Assign FSPlot window size in twips (1440 twips = 1") in order to fix the graph size. This is useful when storing a series of graphs on disk. csize (50-300) is relative character size.

```
PlotSize 8500, 6500, 75
```

Property PlotSubTitle\$...Specify FSPlot secondary title.

```
PlotSubTitle = "Visit Princeton today!"
```

Property PlotTableGrid\$...String specifying table contents in grid format where columns are TAB delimited, rows are CRLF delimited. In the following sample code (generated in FSPlot via **File...Create BASIC Setup**) values such as "550 nm" need to be replaced by functions.

```
PlotTableGrid="Center "& vbTab & "550 nm" & vbCrLf & _
    "Maximum " & vbTab & "98.23 %" & vbCrLf & _
    "50% Bandwidth " & vbTab & "4.25 nm"
```

Property PlotTitle\$...Specify FSPlot main title.

```
PlotTitle = "Fred is great!"
```

Property PlotTitleFont\$...Specify font for FSPlot title

```
PlotTitleFont = "Poster Bodini"
```

Property PlotTitleSize%...Specify FSPlot relative title size (50-150).

```
PlotTitleSize = 110
```

Sub PointPlot(xp!, yp!, Optional kColor&, Optional kWidth%, Optional Radius!)...Plot single point as circle on main graph; optionally adjust color (default is current line color), line width (default 2), % radius (default 1). You can define colors with QBColor (16 colors) or RGB (256³ colors).

```
PointPlot 550,6.75 ' plot point: 550 nm, 6.75%
PointPlot 550,6.75,,3,2 ' thicker circle, larger radius
PointPlot 550,6.75,QBColor(11),3,2 ' cyan
```

Function Reading!(wave!, Optional UseMemVal As Boolean)...Slew to the specified wavelength (wavenumber for IR models), pause for Delay * Time Constant (depending on instrument) and return the ordinate in transmittance units 0-1. There is no correction for baseline, reference, etc. Readings must be preceded with comPortOpen and followed by comPortClose. Set UseMemVal = True to use Baseline or Reference value in memory.

```
comPortOpen
ScanType = 2 ' Baseline
cbas = Reading(500, True) ' Scan or file value
ScanType = 3 ' Reference
cref = Reading(500, True) ' Scan or file value
ScanType = 4 ' Standard
```

```

cstd = Reading(500)          ' File value
ScanType = 1 ' Sample
csmp = Reading(500)          ' Read instrument
y = 100*cstd*(csmp-cbas)/(ceref-cbas) ' Final in %
comPortClose

```

Sub Replot...Replot current spectrum.

```
Replot
```

Sub ReportPrint...Print the current report without displaying it

```
ReportPrint
```

Sub ReportSave(file\$)...Save report (not displayed) as binary printer file; include path and extension.

```
ReportSave "c:\winfilm\reports\dwdm.bin"
```

Sub ReportShow...Preview report and optionally print it.

```
ReportShow
```

Sub Scan(Optional Plot As Boolean=True, Optional wMin!, Optional wMax!, Optional wInt!, Optional wList\$)...Acquire spectral data. Optionally specify new wavelength range or wavelength list file (assuming that list has been specified in the Scan Method).

```

Scan ' scan and plot (using current scan range)
Scan False ' scan without plot
Scan ,400,800,2 ' scan and plot 400-800x2 nm
Scan True,400,800,2 ' same as above
Scan False,400,800,2 ' same scan range but no plot
Scan ,,,"cie1nm" ' use wavelength list cie1nm

```

Sub ScanBlank...HP 8453 blank scan

```
ScanBlank
```

Property ScanParams\$...Get string showing current Scan Method.

```
s$ = ScanParams
```

Property ScanRange!(i, j)...Get scan range in current wavelength units; i: 1 Sample, 2 Baseline, 3 Reference; j: 1 Min, 2 Max, 3 Interval

```
wMin = ScanRange(1, 1) ' min sample wavelength
```

Property ScanTypes%...Indicates whether Baseline and Reference scans are utilized in the scan method. (1 Baseline, 2 Reference, 3 both.)

```

If (ScanTypes And 1) > 0 Then ' Baseline scan
If (ScanTypes And 2) > 0 Then ' Reference scan

```

Sub SetCieMode(mode%, observer%, response%)...*Mode 1: 1931 x,y; Mode 2: 1960 UV; Mode 3: 1976 L*U*V; Mode 4: 1976 L*a*b*; Observer 1: 2°; Observer 2: 10°; Response 1: photopic; Response 2: scotopic.*

```
SetCieMode 2, 1, 1
```

Sub SetIlluminant(type%, degrees!)...Assign illuminant (and blackbody temperature in degrees Kelvin) for CIE color calculations. *Type* corresponds to the CIE Setup Parameters Illuminant list as follows: *Type 1* Black Body;

Type 2-11 Illuminants A, C, D50, D55, D65, D75, E (uniform), F2, F7, F11;
Types > 11 User .

```
SetIlluminant 1, 5500 ' 5500 deg blackbody
SetIlluminant 6      ' Illuminant D65
```

Sub SetPolarizer(vAngle!)...Change Scan Method polarizer angle to 0-360° in PE HP spectrophotometers. Implemented in subsequent scan.

```
SetPolarizer 45.3
```

Sub SetURA(vAngle!)...Change Scan Method URA angle to 8°-68° in PE Lambda HP spectrophotometers. Implemented in subsequent scan.

```
SetURA 50.2
```

Sub Shutter(Position%)...Position: 0 out, 1 in (983/983G only).

```
Shutter 1
```

Sub sMsgBox(text\$, type%, title\$)...Similar to BASIC's MsgBox but modal within MEASURE. This prevents covering the dialog by clicking on the MEASURE window. Can be automatically closed; see MsgBoxTimer. Type = 6 deletes buttons and closes the box in 5 seconds unless MsgBoxTimer is set for a longer interval.

```
sMsgBox "Get a cup of coffee!", 48, "Working Hard"
```

Property Spectrum_X As Variant...Assign/get spectral wavelength values.

Property Spectrum_Y As Variant...Assign/get spectral Y values (reflectance, transmittance, etc.)

```
' Transfer spectra from MEASURE
Option Base 1
DefInt I-N
DefSng A-H, 0-Z
Sub Main
  ReDim xd(1), yd(1)
  xd = Spectrum_X ' Get X values
  yd = Spectrum_Y ' Get Y values
  For i = 1 To UBound(xd)
    Debug.Print xd(i)
    Debug.Print yd(i)
  Next i
End Sub

' Transfer spectra to MEASURE
Option Base 1
DefInt I-N
DefSng A-H, 0-Z
Sub Main
  ReDim xd(17), yd(17)
  For i = 1 To Ubound(xd)
    xd(i) = 400 + 25*(i - 1)
    yd(i) = .3 + .02*(i - 1)
  Next i
  Spectrum_X = xd ' Set X values
```

```
Spectrum_Y = yd ' Set Y values
End Sub
```

Sub StatusLabel(s\$)...Display label in status window.

```
StatusLabel = "Visit Princeton soon"
```

Property Template\$...Assign/get Report Generator template. This should be done before showing or printing the report.

```
s$ = "<<Name Arial>><<Size 24>>" & chr$(13) & chr$(10)
Template = s$ & "FilmStar for Windows"
k = Macro("ShowReport;")
```

Use BASIC's file capabilities to load templates from disk:

```
Open "c:\fstemp\catalog.txt" For Output As #1
Print #1, Template
Close #1
```

```
Open "c:\fstemp\catalog.txt" For Input As #1
Template = Input$(Lof(1),1) ' do not add '$' here
Close #1
k = Macro("PrintReport;")
```

TestFile\$(kType%)...Specify spectral data file for test mode: kType=1 Sample, 2 Baseline, 3 Reference. Optional path and extension.

```
TestFile(1) = "filt001"
TestFile(1) = "h:\spectra\filt001.csv"
```

TestMode As Boolean...Returns True or False depending on whether Test Mode was set in **File...Configuration...Preferences**.

```
k = TestMode
```

Property TypeDataCopy%...Assign spectra copy/paste format: 0 0-1, phase radians; 1 0-100%, phase degrees

```
TypeDataCopy = 0
```

Property TypeDataFile%...Assign spectra file format: 0 .csv (+100 Excel format, +1000 two-column format), 1 .dx, 11 .dx for PE

```
TypeDataFile = 1
```

Property TypeWaveCopy%...Assign Spectra copy/paste wavelength format: 0 nm, 1 current units

```
TypeWaveCopy = 1
```

Property UserName\$...Get User Name (set in File...Configuration...Directories)

```
S$ = UserName$
```

Sub WaitTillReady...Wait in a loop until the Main Menu gets the focus. This prevents a BASIC program from proceeding when other MEASURE windows are activated. The following code changes the color scale to 1976 CIE L*U*V*, closes the CIE Color Module and returns to the Main Menu.

```
MainActivate
SendKeys "^c^p{HOME}{DOWN}{DOWN}%o%{F4}", 1
WaitTillReady
```

Property WaveUnit\$...Get current wavelength unit: *N* nm, *M* μm, *A* Ångstroms, *C* 1/cm

```
S$ = WaveUnit$
```

Sub WbActivate...Activate the FilmStar Workbook. This is similar to pressing **[F3]** from the Main Menu except that the Auto Open Group is disabled.

```
WbActivate
```

Sub WbClear(cells\$)...Clear cells with address or named region cell\$. If more than one worksheet is open, use a unique named region or specify the worksheet to ensure the correct cell is cleared.

```
WbClear "B14:D28" or  
WbClear "Sheet7!Average" ' specifies worksheet
```

Sub WbCopy(cells\$)...Copy contents to clipboard.

```
WbCopy "B14:D28" or  
WbCopy "mtable.xls!Average"
```

Sub WbCloseAll...Close all open worksheets. This occurs instantly without prompting to resave changed sheets.

```
WbCloseAll
```

Sub WbExecute(Optional cmd\$)...Run Workbook macro command. If optional cmd\$ is blank or missing then use macro defined in Workbook.

```
WbActivate ' make sure that Workbook has focus  
            ' (not required for hidden Workbook)  
WbExecute ' run the macro defined in Workbook
```

Sub WbExit...Close the Workbook.

```
WbExit
```

Function WbGetNum(cell\$)...Get number from a spreadsheet cell. If you use cell references instead of a named region and if more than one sheet is open, be sure to include the name of the sheet as shown below. Be sure that any cell name you specify actually exists!

```
v! = WbGetNum("Average") ' look in all open sheets  
v! = WbGetNum("mtable.xls!Average")  
v! = WbGetNum("mtable.xls!g23")
```

Function WbGetText(cell\$)...Get text from a spreadsheet cell. (See WbGetNum for remarks about cell names.)

```
s$ = WbGetText("PassOrFail")
```

Function WbOpen%(file\$)...Open worksheet. Include path and extension. More than one worksheet can be opened. Returns -1 (true) if successful. *Note that this was Sub WbOpen prior to Version 1.8.*

```
k = WbOpen(PgmPath & "\workbook\mtable.xls")
```

Function WbOpenHidden%(file\$)...Open hidden worksheet. Include path and extension. Only one worksheet can be opened. Returns -1 (true) if successful. Hidden worksheets enable users to do looping calculations without annoying flicker and about 250% faster.

```
k = WbOpenHidden(PgmPath & "\workbook\mtable.xls")
```

Sub WbPaste(cell\$)...Paste contents of clipboard.

```
WbPaste "C1"
```

Data can be transferred from one worksheet to another as follows:

```
WbCopy "mtable.xls!b4:b6"
```

```
WbPaste "sheet7!a1"
```

Sub WbRecalc...Recalculate the active worksheet.

```
WbRecalc
```

Sub WbRecalcAll...Recalculate all worksheets. This may be required if WbRecalc fails to produce desired results.

```
WbRecalcAll
```

Sub WbResetLoop...Resets Worksheet Data Loop. Useful for hidden worksheet calculations using multiple data columns.

```
WbResetLoop
```

Sub WbSetFormula(cell\$, text\$)...Set formula in a spreadsheet cell. Cell location or defined name can be used. Note that the equal sign is not included in the expression for the formula.

```
WbSetFormula "Average", "AVERAGE $C$3:$C45"
```

```
WbSetFormula "$C$5", "AVERAGE Reflectance"
```

Sub WbSetName(defname\$, range\$)...(Re)assign Workbook defined name. Especially useful for moving DataMarker in complex models requiring multiple spectral ranges. Reassigning DataMarker resets data looping. Note that there is a DDE macro version of this command.

```
WbSetName "DataMarker", "$A$100"
```

Sub WbSetNum(cell\$, value!)...Set numerical value in a spreadsheet cell. Cell location or defined name can be used.

```
WbSetNum "StdDeviation", 1.45
```

```
WbSetNum "$C$5", 1.45
```

Sub WbSetText(cell\$, text\$)...Set text in a spreadsheet cell. Cell location or defined name can be used.

```
WbSetText "Name", "Edgerstoune Optics"
```

```
WbSetText "$C$5", "Edgerstoune Optics"
```

Sub WbWindow(kState)...Set Workbook window state: 0 normal, 1 min, 2 max

```
WbWindow 0
```

Sub WriteIniString(section\$, key\$, text\$)...Store user-define initialization variables in measure.ini.

```
WriteIniString "Chuck Vogel", "LastFileName", "WW098909"
```

inserts/modifies the following entry in measure.ini:

```
[Chuck Vogel]
```

```
LastFileName=WW098909
```

Communications Functions and Subroutines

Advanced users may take advantage of communications facilities added for the Lambda 900. These functions may be useful for other models as well. They are not supported for the Spectrum 2000 FTIR. See **Reading** above, noting macro commands: OpenPort and ClosePort.

Sub comBreak()...Sends break character to abort action.

```
ComBreak
```

Function comLine\$(timeout!)...Waits and returns line from spectrophotometer. Timeout in seconds; use after ComSend.

```
s$ = ComLine$(5)
```

Sub comPortClose...Close serial communications port.

```
comPortClose
```

Sub comPortOpen...Open serial communications port.

```
comPortOpen
```

Sub comReplyOK(timeout!)...Wait for instrument OK (ready) signal. Timeout in seconds; use after ComSend.

```
comReplyOK(5)
```

Sub comSend(command\$)...Send command to instrument.

```
comSend "SYST:ID?"
```

Sub comWaitString(string\$, timeout!)...Wait for string from instrument. Timeout in seconds; use after ComSend.

```
comWaitString "0099", 10
```

Auxiliary Communications Functions and Subroutines

Advanced users may take advantage of communications facilities added to control or trigger external devices. In a typical application, serial port COM2 communicates with a programmable logic controller (PLC).

It may be necessary to disconnect the Lambda Server (Mpe950.exe) or Lambda-AX Server (Mpe19AX.exe) when performing auxiliary communications. Use Sub Disconnect followed by Sub Initialize.

Function comAuxLine\$(timeout!)...Waits and returns line from auxiliary port. Timeout in seconds. Error returns "***ERROR***"

```
s$ = comAuxLine$(5)
```

Sub comAuxPortClose...Closes auxiliary serial port.

```
comAuxPortClose
```

Sub comAuxPortOpen(port%, params\$, Optional handshake%, optional Advanced%)...Open serial communications port.

```
comAuxPortOpen 2, "9600,N,8,1"      ' RTS/CTS  
comAuxPortOpen 2, "9600,N,8,1", 1   ' XON/OFF
```

Handshake: 0 None, 1 XON/OFF, 2 (default) RTS/CTS, 3 RTS and XON/OFF; advanced: +1 enable CD errors, +2 enable CTS errors, +4 disable timeout errors

Sub comAuxSend(command\$)...Send command to device

```
comAuxSend "S" & vbCr
```

Function comAuxWaitString(string\$, timeout!) as Boolean...Wait for string from device. Timeout in seconds. Returns False if error.

```
If Not comAuxWaitString("H", 120) Then _  
    MsgBox "Timeout error": End
```

FilmStar Workbook

The Workbook is an Excel-compatible programmable spreadsheet (Microsoft Excel not required) for calculations. This offers great flexibility in setting up optimization problems.

The Workbook contains worksheets and menu commands. Each worksheet has its own file. For convenience, several worksheets can be loaded together in a group. A group could contain the main calculation worksheet, an index function worksheet, and an illuminant worksheet. At present there is no macro language as in Excel, but most Excel Version 5.0/95 spreadsheet formulas are supported. (When we refer to *Macro* we mean a series of commands sent to MEASURE.)

File Menu

Most commands will be familiar to spreadsheet users. Worksheet files can be loaded and saved in native .vts or Excel 5.0-compatible .xls format. Worksheet files can be saved in groups and loaded with hot-keys **<Shift+F1>...<Shift+F4>**.

Microsoft Excel files saved in 5.0/95 format can be opened in the FilmStar Workbook. Features from newer Excel versions, such as multiple sheets, are not supported.

Open Worksheet Groups...Edit Groups <Ctrl+G>

This leads to the Edit Worksheet Groups dialog box.

Group Name...Assign a name to appear in the Open Worksheet Groups menu alongside the hot-keys **<Shift+F1>...<Shift+F4>**.

Files in Group...Click on a file name to place it in the **File Name** editor or remove the file from the group by pressing **Delete File**.

Files Name...Typing in this text box activates the **Add File** button.

Printer Setup

Headers and footers can contain text and special formatting codes as follows:

&L	Left-aligns the characters that follow
&C	Centers the characters that follow
&R	Right-aligns the characters that follow
&D	Prints the current date
&T	Prints the current time
&F	Prints the worksheet name
&P	Prints the page number

The following font codes must be placed before the preceding ones.

&B	Bold
&I	Italic

&"fontname" Use the specified font
&nn Use the specified font size (2 digit number)

Evaluate Menu

Execute Macro <F8>

Execute MEASURE commands contained in a worksheet cell or group of cells with defined name *Macro*. Commands are identical with those listed under "Macro Reference (DDE)" on page 26. Note that similar macros are available in the Main Menu.

Reset Data Loop <Ctrl+F8>

If looping is enabled (see *Data Type* below) multiple scans are placed in adjacent worksheet columns. Users can then develop functions of several spectra. This command resets column position to the first column.

Recalculate <F9>

Only the active window is recalculated.

Auto Recalculate

Recalculation of all open windows is automatic if this entry is checked.

Formulas

Many Excel-compatible formulas are supported in the FilmStar Workbook. An A-Z Function Reference is provided in help file *wbfs_az.hlp*. This file may be accessed from the FilmStar Workbook by clicking **Help...Function Reference <Ctrl+F1>**. Note that Workbook models developed for fixed wavelength or angle ranges will be far simpler than models which allow any range.

Defined Names

A worksheet communicates with MEASURE's calculation and optimization routines through four reserved defined names:

DataMarker, DataType, Macro, Passed

These are assigned to a worksheet file with **Edit...Defined Names**.

These reserved names must be in a single worksheet. In addition all spectral calculations should be in the same worksheet.

DataMarker

Following a scan, the spectrum is transferred to the active worksheet below the *DataMarker* cell. Data transfer is automatic whenever the Workbook is activated by pressing <F3> or by clicking on it.

If *DataMarker* is not defined, users can paste spectral data manually by copying the data to the clipboard in MEASURE (**Spectra...Copy Data**) and pasting it with **Edit...Paste <Ctrl+V>**.

Data Type

This integer contains the following bit values:

<i>Format</i>	Bit 0 (+1)	Formatting enabled
<i>Loop</i>	Bit 1 (+2)	Looping enabled
<i>One Column</i>	Bit 3 (+8)	Paste one data column (R or T...not both)
<i>No Paste</i>	Bit 4 (+16)	Suppress data auto-pasting

Formatting adds labels and displays percent values for R and T rather than 0-1.

Looping makes it possible to utilize multiple spectra in the Workbook. Each time the Workbook is activated a new spectrum is pasted to the right of the previous one. To start again, click **Evaluate...Reset Data Loop <Ctrl+E>** before deactivating the Workbook and returning to the Main Menu.

Looping is automatically enabled when macros are run. That is, if the macro includes multiple scans, spectra are automatically pasted into adjacent columns without having to set *DataType* bit 0. (It is not necessary to include a zero *DataType* cell in a worksheet. If it is missing, it is the same as 0.)

%T and %R columns plus the wavelength column are normally pasted into the worksheet at *DataMarker* each time it is activated. If *Datatype* bit 3 is set then only one column is pasted as shown above. If *Datatype* bit 4 is set then the current spectrum will not automatically paste into the Workbook when it is activated.

Macro

A worksheet can 'send' commands to MEASURE. Commands are identical with those listed under "Macro Reference (DDE)" on page 26. Commands can be grouped in one cell {D1="DATATYPE SAMPLE;SCAN;"} or in a single column (easier to read). Each command is terminated with a semicolon. Macro commands must be assigned defined name *Macro*. There is no macro language for the Workbook itself.

Click **Evaluate...Execute Macro <F8>** to run command macros. When macros containing multiple *SCAN* or *SCANPLOT* commands are run, spectra are automatically pasted into adjacent columns.

Passed

A logical function evaluating to *TRUE* if the spectrum passes some specification and *FALSE* if it fails. The formula for a typical *Passed cell* might be

$$=AND(E5<0.005, E6<0.01) .$$

where E5 is average reflectance and E6 is maximum reflectance. This allows users to set up quality-control criteria in the Workbook.

CIE Color Module

The CIE Color Module provides facilities for evaluating color coatings where there is a single color specification. More complex cases (*i.e.* color requirements in reflection *and* transmission or color requirements over an angle range) can be set up in the Workbook. The module is activated from the Main Menu by clicking Evaluate...**CIE Color <Ctrl+F9>**. To exit the module, click on the Main Menu or press **<Esc>**. Close the module with **<Alt+F4>**.

CIE color calculations are only possible when the scan range is 380-780 x 5 or 1 nm. Otherwise the selection is grayed.

Module parameters are stored with the Scan Method.

Setup Menu

Parameters <Ctrl+P>

Modes...Four calculation modes are current supported: CIE 1931, CIE 1964, CIE 1976 L*U*V*, and CIE 1976 L*a*b*.

If you change modes you can get the 'Overflow' error because displayed graph axes are out-of-range for the new calculation. Fix this by adjusting graph axes.

Observer...2° and 10° observers may be selected.

Illuminant...Black body and illuminants A/C/D50/D55/D65/D75/E plus fluorescent F2/F7/F11 are included. Users can define any number of additional illuminants as ASCII files stored in the MEASURE program directory (usually ..\winfilm). Each file includes a single column of numbers giving the relative intensity from 380 to 780 x 5 nm (or 1 nm). Illuminant descriptions and corresponding file names are entered in measure.ini as described in “Configuration - Preferences” on page 9.

User-illuminant files are defined from 380 to 780 x5 nm or x1 nm intervals. There must be 81 or 401 entries.

Calculation Interval...An interval of 5 nm is sufficient for most color calculations. When 1 nm spacing is specified, the module generates 1 nm tables from 5 nm CIE data. The finer interval will only be required if there are exceptionally sharp spectral features. If there are sharp spectral features in the source, users can construct 1 nm user-illuminant files. (1 nm illuminant files can be utilized in 5 nm calculations.)

Tolerance Box...Acceptability polygon. Color coordinates pass the specification if they are in the box. Enter coordinates in clockwise order for each point describing a convex polygon. Coordinates are comma and line separated as shown. A convex polygon is shown at the left; the concave polygon (one or more sides with internal angle > 180 degrees) will not work.

.27, .27	↑
.29, .33	
.33, .33	
.31, .27	↓

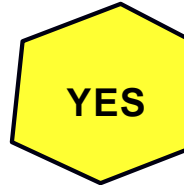

Evaluate Menu

Calculate <F9>

Click if the module fails to recalculate automatically. If you don't see coordinates drawn as a circle, try **Draw New Axes <Ctrl+A>** followed by <F9>.

FSPlot Graphing Module

The FSPlot Graphing Module creates publication-quality graphs for proposals, reports and publications. It has its own memory and can store spectra independent of the main program. FSPlot graphs may be combined with text in the “Report Generator” (see page 57).

After scanning a spectrum (vs. wavelength or angle) in the Main Menu, click **Tools...FSPlot Module <F4>** to activate the graphing module. Click **Plot** and the graph is replotted. Each spectrum must have exactly the same horizontal axis values. This can be a problem when importing data from disk files. Use **Convert Table <Ctrl+F8>** in the Main Menu to equalize horizontal axis spacing.

File Menu

Save As <F12>

Save the graph as a Windows metafile (.wmf) or bitmap (.bmp, .png). This can then be imported by word processors or graphics programs. Use PNG (Portable Network Graphics) for web graphics; bitmap (.bmp) files are large and should not be posted to web sites or sent as e-mail attachments.

Copy <Ctrl+C>

Copy to the clipboard. The image can be pasted into word processors or graphics packages. The image will be a metafile (vector) or bitmap according to *Graphics Mode* setting.

Bitmap Size

This enlarges the bitmap (PNG recommended) to match printer resolution.

Create BASIC Setup

Creates FilmStar BASIC code describing the current FSPlot configuration. The code is copied to the clipboard for pasting into the BASIC editor.

Reload Setup

Reloads the FSPlot configuration stored in measure.ini. This is useful if you have temporarily changed colors and wish to return to a standard format.

Disable Save

Normally the current FSPlot configuration is stored in measure.ini upon exiting FilmStar MEASURE. Check this box to disable that function. Save can also be disabled by setting *PlotNoSave=True* in FilmStar BASIC.

Setup Menu

Once a format (including the size of the FSPlot window) is decided upon, it is saved upon leaving MEASURE. Try a dark background for 2x2" slides. For monochrome printing, enabling Grays may be preferable to Patterns. The lack of thick patterned lines is a Windows limitation.

Plot %T and OD

This mode is supported when Optical Density is selected in Scan Method. Here the left hand axis is T = 0-100% while the right hand axis is optical density according to Graph Axes settings. When switching this mode it may be necessary to close and reopen the FSPlot Module.

Transmittance Format

When the vertical axis is transmittance, there are options for two Schott diabatic scales 0-1 and 0-100% in addition to the 0-100% linear scale. This format makes it easy to visualize both passband and blocking regions.

Legends

Legends and a subtitle are added to the graph in the Graph Legends editor. Note that subtitle font size is fixed relative to title font size.

Table

A table annotation can be added to the graph. This is used to display summary calculated results in a convenient format. As such, it is normally used in conjunction with FilmStar BASIC.

Graph Details <Ctrl+H>

This dialog provides a vast number of customization options. An updated graphics engine was implemented in MEASURE 2.50.0000. This may effect line thicknesses in graphs created by earlier versions.

Enable DAQ Plots

Adds menu **DAQ-Plot** which contains commands for plotting as-acquired data. When using this, it is recommended to set *Auto Y-Axis Label* to false in the main menu Graph Details dialog and to use legends to label the plots.

Data Menu

File and clipboard operations make it possible to open and save data associated with multiple plots. Data is saved in Excel-compatible .csv format (no header).

Formulator <Ctrl+F>

Create and edit a Plot Formula for arithmetic operations on displayed data sets. The Plot Formula is stored with the Scan Method.

Run Formula <Ctrl+R>

Apply an existing Plot Formula to the displayed data. Doing this twice in a row can have unwanted consequences. If that happens and only one data set is being used, click **Delete #1** and **Plot** to recover the original graph.

Annotations

Annotations (stored with Graph Axes) may be added to FSPlot graphs. This is especially useful for quality control.

graph x, y, type, text, color... Draw lines and place text anywhere. When drawing a series of lines *text* is blank and at two or more *graph* statements are required. The first *graph* statement uses the following *type* values:

Thin solid = 38; Dash = 39; Dot = 40
Dash dot = 41; Dash dot dot = 42
Medium solid = 43; Thick solid = 44

Subsequent *GRAPH* statements in a line series use the following *type* value:

Continue line = 45

Other values of *type* add text with numerous optional symbols. Some of these types are indicated below. Other values may be determined by examining the annotation after using the Annotator.

0 none; 1 plus; 2 cross; 4 solid dot; 6 solid square;
37 pointer

Color values are correspond to RGB values 0 to 16777215. This is different from older versions which allowed 16 colors. Older versions are automatically converted, as indicated by header line *VERS2*.

In the example below, *a-d* define the first series of lines, and *e-h* define the second line series. Note that the left-hand axis is used for coordinates *x, y*.

hline y, type, text, color... Draw a horizontal annotated line. Line *type* is as follows:

- Thin solid = 0; Dash = 1; Dot = 2
- Dash dot = 3; Dash dot dot = 4
- Medium solid = 5; Thick solid = 6

In the example below, *k* illustrates the use of *hline*. Colors are as listed above under *graph*.

vline x, type, text, color... Draw a vertical annotated line. Line *type* is as listed above for *hline*. Illustrated in the example below in lines *l,m*.

axis x, text, color... Label special positions on the horizontal axis. As illustrated below in *n,o* closely spaced laser lines can be marked without overlapping text. A similar **axis** statement is also available.

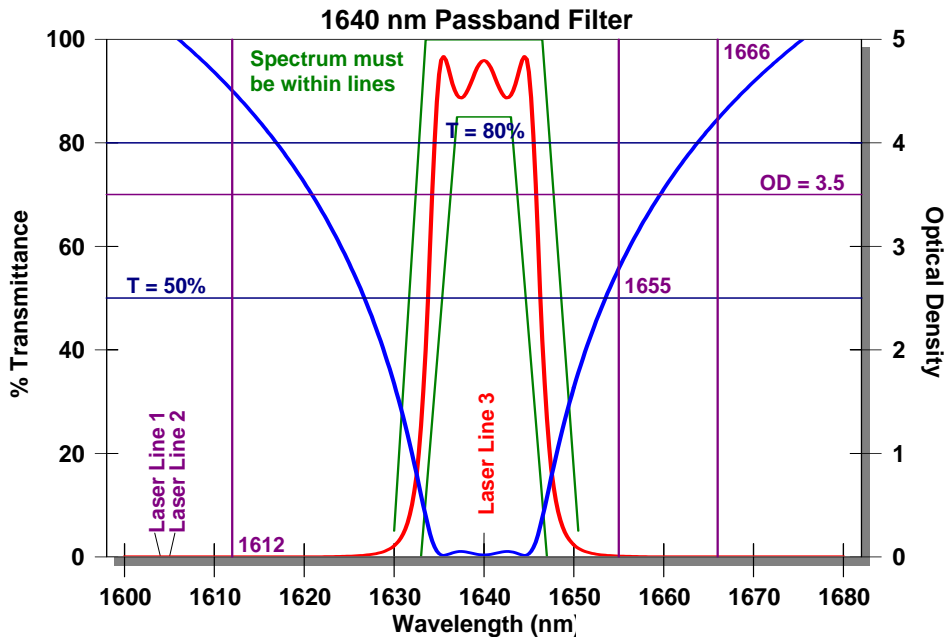

Note that letters *a...*s just identify statements and are not actually included in the annotation editor. Do not remove the header line *VERS2*.

VERS2

- a. graph 1630, 5, 43,, 32768;0
- b. graph 1633.5, 99.9, 45,, 32768;1
- c. graph 1646.5, 99.9, 45,, 32768;2
- d. graph 1650.5, 5, 45,, 32768;3
- e. graph 1633, 0, 43,, 32768;4
- f. graph 1637, 85, 45,, 32768;5
- g. graph 1643, 85, 45,, 32768;6
- h. graph 1647, 0, 45,, 32768;7
- i. graph 1614, 94, 0, Spectrum must, 32768;8
- j. graph 1614, 89, 0, be within lines, 32768;9
- k. hline 70, 5, |rOD = 3.5, 8388736;0
- l. hline 80, 5, |cT = 80%, 8388608;1
- m. hline 50, 5, |T = 50%, 8388608;2
- n. vline 1612, 5, |b 1612, 8388736;0

```

o. vline 1655, 5, |c 1655, 8388736;1
p. vline 1666, 5, |t 1666, 8388736;2
q. xaxis 1604, Laser Line 1, 8388736;0
r. xaxis 1605, Laser Line 2, 8388736;1
s. xaxis 1640, \\Laser Line 3, 255;2

```

Hline labels are justified with codes |L (left outside), |l (left inside), |c (center), |r (right inside) and |R (right outside) where "|" is the pipe symbol (shift backslash). *Vline* labels are justified with codes |B (bottom outside), |b (bottom inside), |c (center), |t (top inside) and |T (top outside).

As illustrated in *s*, backslashes ("\") in *text* fields are converted to spaces. In addition reverse quotation marks ("") are converted to commas.

The system automatically adds a semicolon and index number to each annotation. This identifies the annotation to the Annotator.

Annotator

As an alternative or supplement to manual entry, annotations can be added and edited interactively. You can also use the Annotator to edit annotations previously entered manually.

Click on the FSPlot graph region with the left mouse button to bring up the Annotator dialog box. Note that mouse x,y coordinates are automatically transferred. The annotation is actually added when **Add** is clicked. Once the annotation is drawn, return to the graph region and locate it with the mouse. Observe that the cursor changes to a hand shape. Now click again and note that the **Add** button has been changed to a **Replace** button. In addition a **Delete** button becomes visible.

To draw line segments select **Type New Line Segment** and click **Add**, followed by one or more *Continue Line Segments*, clicking **Add** for each new segment. To add temporary annotations (not stored with the Scan Method), clear the **Permanent** check box. In the annotation editor temporary annotations include a tilde ("~") before the annotation line.

Formulator

The FSPlot Formulator modifies data displayed in graphs. Typical applications might include manipulating data values to show detail, averaging curves, plotting difference between curves, etc.

After plotting all required curves, click **Edit...Formulator (Ctrl+F)** in the FSPlot Module. Enter an appropriate formula and click **Apply**. Examine the data in the grid as well as the FSPlot graph; if incorrect click **Revert** to restore the original data array. Finally, click **Close** to exit. In the illustrated example the following formula is used:

```

C=B;
B=if(A>420 & A<520, 100*B, if(A>650 &
A<850, 100-(100-B)*20, B))

```

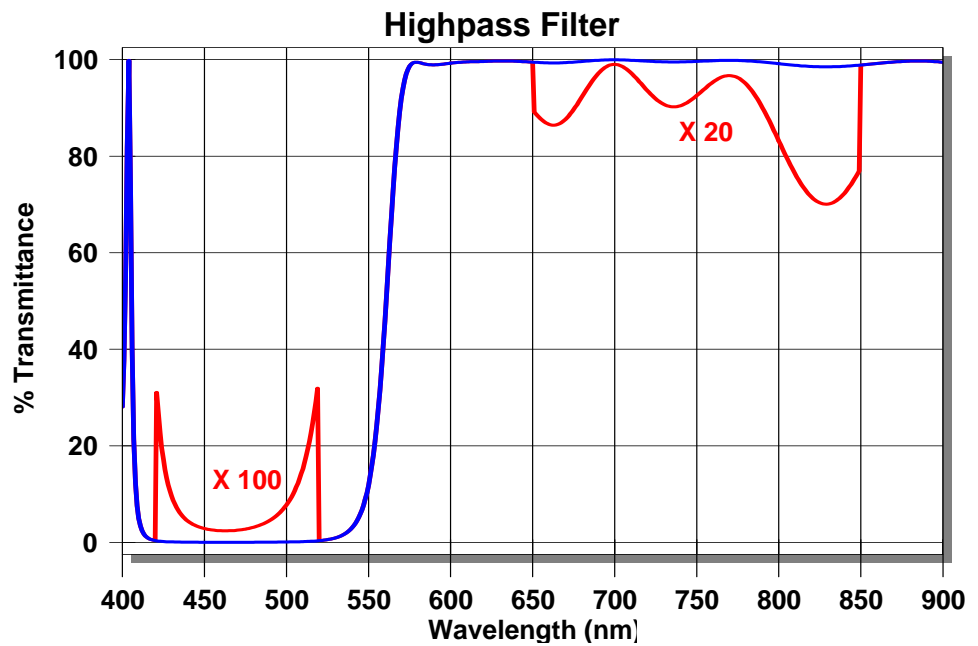

Multiple formulas are separated by semicolons (;). Letters refer to columns A-M (A is wavelength, B is first data set, etc.). The following operators are supported

- + Addition
- Subtraction
- ^ Exponentiation
- * Multiplication
- / Division
- & Logical And
- | Logical Or

The following functions are also supported:

- if(X,Y,Z) If X is true Y is returned, otherwise Z is returned
- abs(Y) Absolute value

Special operator *del* deletes unwanted data columns

- del C Remove column C

For example

```
D=.5*(B+C);del B;del B
```

yields columns A and B where B is the average of the two original columns A and B. Note that *del* is always used at the end of a formula.

Report Generator

Using ComponentOne's VsPrint7.ocx module the Report Generator combines text and graphics in multi-page documents.

While the Report Generator is not a word processor, it provides many word processor printing features including print preview. Reports may be saved in three formats: binary (.prt) for reprinting in FilmStar, Adobe Acrobat (.pdf), and rich text (.rtf). Rich text may be opened in MS Word and resaved in .doc format.

Report Setup

The options in this dialog box are the default format options for the report. Options can be changed throughout the document by using formatting field codes in the Template.

Header/Footer

Headers and footers are composed of three sections separated by pipe characters ("|"). The first section is left-justified, the second is centered, the third is right-justified. A page number field is embedded by including the code "%d" in the text; use code "%d/n" to add total number of pages (*i.e.* Page 3/7). In the following example the second section is blank:

```
FilmStar Report Generator||Page %d/n
```

In the next example only the second section is used:

```
|FilmStar Report Generator Page %d/n|
```

Headers and footers use default report fonts which can be changed by clicking **Fonts**. In the header or footer fonts are printed italic if the default font is not italic, and vice-versa.

Margins & Line Spacing

Margins are in inches or mm. Line spacing is expressed as percent of font size. Margins should be the same throughout any document.

Metric Paper

When metric paper is selected, margins and some other length settings will be in mm instead of inches.

Color Printer

This toggles whether the print preview shows colors. Memory is saved by displaying monochrome graphics. It does not affect the actual printout.

Auto Preview

This toggles whether print preview is updated automatically whenever conditions are changed. When disabled a **Preview** button appears in the Report Generator main menu.

Show Graphics

This toggles whether graphics are displayed in the preview. When turned off graphics are shown as rectangles. This option saves memory and increases redraw speed. It does not affect the actual printout.

Report Template

The report template includes text and codes. Codes are surrounded by double left and right arrow keys. In the following definitions commands are capitalized and parameters are shown in lower case. When actually typing commands, however, capitalization is unimportant.

Templates are stored with Graph Axes. To keep new templates re-save the Graph Axes file with a different name. Templates can also be assigned in BASIC.

Action Commands

Action commands insert text and graphics.

<<BASBLOCK value>>...Value 0 to 15. Insert text block paragraph(s) created in FilmStar BASIC by assigning BasText\$(0)...BasText\$(15). See IndentFirst,

IndentLeft, and IndentRight. This is useful for paragraphs containing calculated text. Otherwise consider using FileText.

```
<<BasBlock 5>> ' insert block text BasText$(5)
```

<<BASRUN name>>...Run a FilmStar BASIC macro. This provides means to include calculated values in reports, for example average reflectance.

```
<<BasRun c:\winfilm\Basic32\AveRef1.bas>>
```

While the macro could alternatively be assigned to a macro key, including the macro name in the template may sometimes be preferred. The complete path must be given, and *a template containing a BASIC macro cannot be triggered by another BASIC macro.*

<<BASTEXT value>>...Value 0 to 15. Insert string created in FilmStar BASIC by assigning BasText0\$...BasText15\$.

```
<<BasText 5>> ' insert BasText$(5)
```

<<DRAWLINE>>...Insert a horizontal line between the current margins adjusted by IndentLeft and IndentRight.

```
<<DrawLine>>
```

<<FILETEXT name>>...Insert a text file as a paragraph(s). This is useful for proposals and quotations. See IndentFirst, IndentLeft, and IndentRight.

```
<<FileText c:\winfilm\pro1.txt>>
```

<<FSPLOTT zoom, fontsize, width, height>>...Zoom and font size in %, width and height in twips. Insert a graph from the plotting module. The graph is inserted at the screen size times zoom in %. Font size can be adjusted by optionally adding relative values in %. The plotting module window size is adjusted by optionally adding width and height in twips (1 inch = 1440 twips, 1 mm = 56.7 twips). This ensures that graphs are printed at repeatable sizes even if users have altered window dimensions.

```
<<FSPlot>> 'zoom=100%, font size=100%
<<FSPlot 75>> 'zoom=75%, font size=100%
<<FSPlot 75,120>> 'zoom=75%, font size = 120%
<<FSPlot 105,110,7500,6000>> ' zoom=105%, font size=110%
' ht=7500, wd=6500
```

There are two modes: 1. The plotting module is closed when a report is generated and, 2. The module is open (visible). In the first case, each graph automatically plots the latest spectrum. Module operation remains hidden.

If the plotting module is open when a report is generated, the displayed graph is placed into the report. In this case the module is not refreshed automatically with the latest spectrum. To automatically include multiple graphs on a plot, use BASIC function PlotActivate to display the module and PlotNext to add new graphs. To plot reflectance and transmittance on the same graph use macro function PlotSelect. Generate a report with k = Macro("ShowReport;"), and use PlotClose to close the module, erasing all graphs.

After font or window size is adjusted, close and open the Report Generator in order to see the changes. To include multiple graphs in a report, use BASIC function PlotSave to store each graph as a picture. Then use template function Picture (see below) to print graphs.

<<GRAPH zoom>>...Insert the bitmap graph shown in MEASURE's Main Menu. The graph is inserted at the screen size times zoom in %.

```
<<Graph 70>>      ' zoom=70%
<<Graph>>          ' zoom=100%
```

<<PICTURE name, zoom>>...Insert a picture file with .bmp (bitmap) or .wmf (metafile) extension. Pictures are centered between current margins. Zoom is optional and is 100% if not specified. Use Picture in conjunction with BASIC's PlotSave to print documents containing several graphs. Picture is convenient for printing company letterheads and logos.

```
<<Picture d:\winfilm\ftglogo.wmf, 75>> 'zoom=75%
<<Picture d:\winfilm\ftglogo.wmf>>     'zoom=100%
```

<<TABLE>>...Insert current spectrum as a data table.

```
<<Table>>
```

<<WBTEXT cell\$>>...Insert string as formatted in Workbook cell. If only one worksheet is open or if the defined name is unique you can eliminate the worksheet name in the cell name. To get required formatting for numerical values, use the Workbook's TEXT function.

```
<<WbText Rmin>>
<<WbText sheet2!Rmax>>
<<WbText mtable.xls!Average>>
<<WbText mtable.xls!b14>>
```

Format Commands

The simple formatting in the Report Setup dialog box will be sufficient for many applications. Additional formatting is possible with the following template commands.

<<ALIGN type>>...Align text between margins.

```
<<Align 0>>      ' align left
<<Align 1>>      ' align center
<<Align 2>>      ' align right
<<Align 9>>      ' justify
```

Left alignment allows you to format words within a line. In center and right alignment the entire line will have the same formatting.

<<BOLD boolean>>...Font bold or normal.

```
<<Bold 0>>      ' following text is normal
<<Bold 1>>      ' following text is bold
```

<<BORDER value>>...Page border, values 0 to 7: 0 none, 1 bottom, 2 top, 3 top & bottom, 4 box, 5 columns, 6 columns & top & bottom, 7 all. If Border is not specified, a top border is drawn if there is a header and the bottom is drawn if there is a footer.

```
<<Border 4>>    ' draw box around each page
```

<<COLOR value>>...Color 0 to 15: 0 black, 1 blue, 2 green, 3 cyan, 4 red, 5 magenta, 6 yellow, 7 light gray, 8 dark gray, 9 blue, 10 green, 11 cyan, 12 red, 13 magenta, 14 yellow, 15 white. 1-6 are dark versions of 9-14.

```
<<Color 9>>     ' text is blue
```

<<COLUMNS value>>...Print in multiple columns.

<<Columns 2>> ' print in 2 columns

<<COLUMNSPACING value>>...Space between columns. (twips, default 180)

<<ColumnSpacing 240>> ' column spacing is 240 twips

<<DEFFONTS>>...Returns **Name**, **Size**, **Bold**, **Italic** and **Spacing** to default values.

<<DefFonts>>

<<DEFNAME font>>...Sets new default font name. **DefSize**, **DefBold**, **DefItalic** and **DefSpacing** are similar.

<<DefName Lucida Sans Typewriter>>

<<FOOTTEXT text>>...Overwrite the default footer.

<<FootText |This is the footer - Page 1|>> ' footer text

<<HDRBOLD boolean>>...Header and footer font bold or normal.

<<HdrBold 1>> ' header/footer text is bold

<<HDRCOLOR value>>...Header/footer color. See Color.

<<HdrColor 12>> ' header/footer text is red

<<HDRITALIC boolean>>...Header/footer font bold or normal.

<<HdrItalic 1>> ' header/footer text is italic

<<HDRNAME font>>...Header/footer font name

<<HdrName Arial>>

<<HDRSIZE points>>...Header/footer font size.

<<HdrSize 10>> ' header/footer size is 10 points

<<HDRTEXT text>>...Overwrite the default header.

<<HdrText |This is the header - Page 1|>> ' header text

<<INDENTFIRST length>>...Additional left indent for the first line of a paragraph in inches or mm (metric paper).

<<IndentFirst .3>> ' first indent=.3"

<<INDENTLEFT length>>...Left indent in inches or mm (metric paper).

<<IndentLeft .75>> ' left indent=.75"

<<INDENTRIGHT length>>...Right indent in inches or mm (metric paper).

<<IndentRight .75>> ' right indent=.75"

<<INDENTTAB length>>...Tab spacing in inches or mm (metric paper).

<<IndentRight .75>> ' right indent=.75"

<<ITALIC boolean>>...Font italic or normal.

<<Italic 0>> ' following text is regular

<<Italic 1>> ' following text is italic

<<LINECOLOR value>>...Line color used for borders. See **Color**.

<<LineColor 12>> ' borders in red

<<LINEWIDTH points>>...Line width in points used for borders. The default is zero. This may be acceptable for 300 dpi printers but will be probably be too thin for higher resolution printers.

`<<LineWidth 1.5>> ' line width 1.5 points`

<<MARGINS metric, left, right, top, bottom>>...Set English/metric units and margins. Any non-zero value for the first field sets metric paper. If utilized, Margins should be the first command in a template.

`<<Margins 0,.75,.75,.5,.5>> ' English units`

This command is useful for templates created and stored through BASIC. Users can then be sure that margins are correct even if the Graph Axes file was overwritten.

<<NAME font>>...Font name. This must correspond to your printer. See also Size, Bold and Italic.

`<<Name Lucida Sans Typewriter>>`

<<NEWCOLUMN>>...Insert column break.

`<<NewColumn>> ' insert column break`

<<NEWPAGE>>...Insert page break. Page breaks are automatically inserted if a graph is too big for the page.

`<<NewPage>> ' insert page break`

`<<Page>> ' alternative`

<<SIZE points>>...Text font size in points (1" = 72 points)

`<<Size 10>>`

<<SPACEAFTER points>>...Extra space in points (1" = 72 points) to be added after paragraphs.

`<<SpaceAfter 8>> ' 8 point space after paragraphs`

<<SPACING percent>>...Line spacing as a percent of the current font size. The default can be set in the Report Setup dialog box.

`<<Spacing 120>>`

<<UP lines>>...Move up the page. This is helpful when formatting commands have added unwanted white space between lines.

`<<Up>> ' move up one line`

`<<Up 2>> ' move up 2 lines`

General Information

Keyboard Commands

Keyboard commands are generally identical with those in other Windows applications. But the custom grid control warrants some explanation.

Cancel

Upon selecting **Cancel** <Escape> changes in the dialog box are lost. If you are constantly losing data in this manner you should set a cancel confirmation flag. See “Configuration - Preferences” on page 9.

Grid Control

The custom grid control makes it possible to edit large data sets within a dialog box. The control is quickly navigated with the mouse.

Mouse...Click on the required cell. A single cell is selected when highlighted by a box. Note that the box is sometimes a pull-down list. Multiple cells are highlighted in black by holding down the mouse button.

Keyboard...Use <Arrows>, <Home>, <End>, <Ctrl+Home> and <Ctrl+End> to move the focus and scroll the grid. Hold down the shift key to select multiple cells. <PgUp> and <PgDn> also work. <Tab> navigates to the next available cell and moves the focus to the next control if there are no more editable cells. Most grids will not let you enter data more than one row below the last row containing data.

Press or <BkSp> to clear an entry or a selected region. Note that rows can be deleted, inserted and sorted by wavelength. To edit a cell without replacing it (*i.e.* overwrite mode), press <F2> or <Insert>.

The program attempts to prevent erroneous data. In most cases the offending data cell is highlighted in yellow. Additional checks are performed upon clicking the OK button.

Shortcut Keys

There are a number of shortcut keys. Several dialog boxes contain their own shortcut keys (not shown here). Clipboard shortcuts <Ctrl+C> (copy), <Ctrl+V> (paste), and <Ctrl+X> (cut) are used throughout.

<F2>	DB Save Method
<Ctrl+F2>	DB Retrieve Method
<F3>	FilmStar Workbook
<F4>	FSPlot graphing module
<F6>	FilmStar BASIC
<F7>	Activate Report Generator
<Ctrl+F7>	Quick print report
<F8>	View data table
<Ctrl+F8>	Convert spectrum to new interval
<Shift+Ctrl+F8>	Export spectral data via DDE
<Ctrl+F9>	CIE color module
<F11>	Spectral data Save As
<Ctrl+F11>	Spectral data Open
<Shift+F11>	Spectral data Save
<Shift+Ctrl+F11>	DB Save Spectrum
<F12>	Scan Method Save As
<Ctrl+F12>	Scan Method Open
<Shift+F12>	Scan Method Save
<Shift+F1...F6>	Execute command macro #1 to #6

<Alt+A>	Draw new axes and replot spectrum
<Alt+C>	Scan
<Alt+R>	Change plot line color
<Ctrl+A>	Measurement Range editor (Scan Method 3B)
<Ctrl+C>	Copy spectral data to clipboard
<Ctrl+E>	Clear current spectrum from memory
<Ctrl+G>	Graph Axes editor (Scan Method 4)
<Ctrl+H>	Graph Details dialog
<Ctrl+I>	Initialize spectrophotometer
<Ctrl+M>	Edit Scan Method
<Ctrl+Q>	Quick save spectrum in WORK.CSV
<Ctrl+V>	Paste spectral data from clipboard
<Ctrl+Z>	Edit macros

Graphics Labels

Labels may be placed on the screen by pressing **<Shift+Click>** (left mouse button) when the cursor is in the plot area (crosshair shape). Left, center and right justification may be selected as well as an italic font.

Color Button

Click the desired color box to select a new color.

To change colors with the keyboard, press **<Alt+R>**, use left and right arrow keys to select and press **<Enter>**. Colors can also be selected with a single keystroke:

black, Red, Yellow, Blue, Green, Magenta, Cyan, White

Index

A

Annotations 54, 56
Annotator 56
Auto Zero and Background Correction 13

C

Calibrate Wavelength 14
CIE Color Module 51
CIE User-Illuminants 10
Configuration - Capacity 8
Configuration - Directories 8
Configuration - Miscellaneous 12
Configuration - Preferences 9
Configuration - Security 11

D

Data Format 23
Data Type 12, 13
DDE 26
Defined Names 50

F

File Menu 8
FilmStar BASIC 33
FilmStar Report Generator 57
FilmStar Workbook 49
Format Options 23
Formulator 41, 56
FSPlot Graphing Module 52

G

General Information 62
Graph Axes 15

I

Input Device 16
Instrument Settings 18

K

Keyboard Commands 62

M

Macro Reference 26
Measurement Type 20
Measurement Range 19

P

Printer Setup 49
Program Mode 20

R

Report Generator 57
Report Setup 58
Report Template 58

S

Setup Menu 12
Spectra Menu 22
Spectrophotometer Commands 6, 19
Standard Data Editor 25

T

Tablet Procedures 25
Test Mode 2, 9
Tools Menu 26

V

V Reflectance 21

W

Wavelength List 21
Wavelength List Generator 21